

USER & INSTALLATION MANUAL

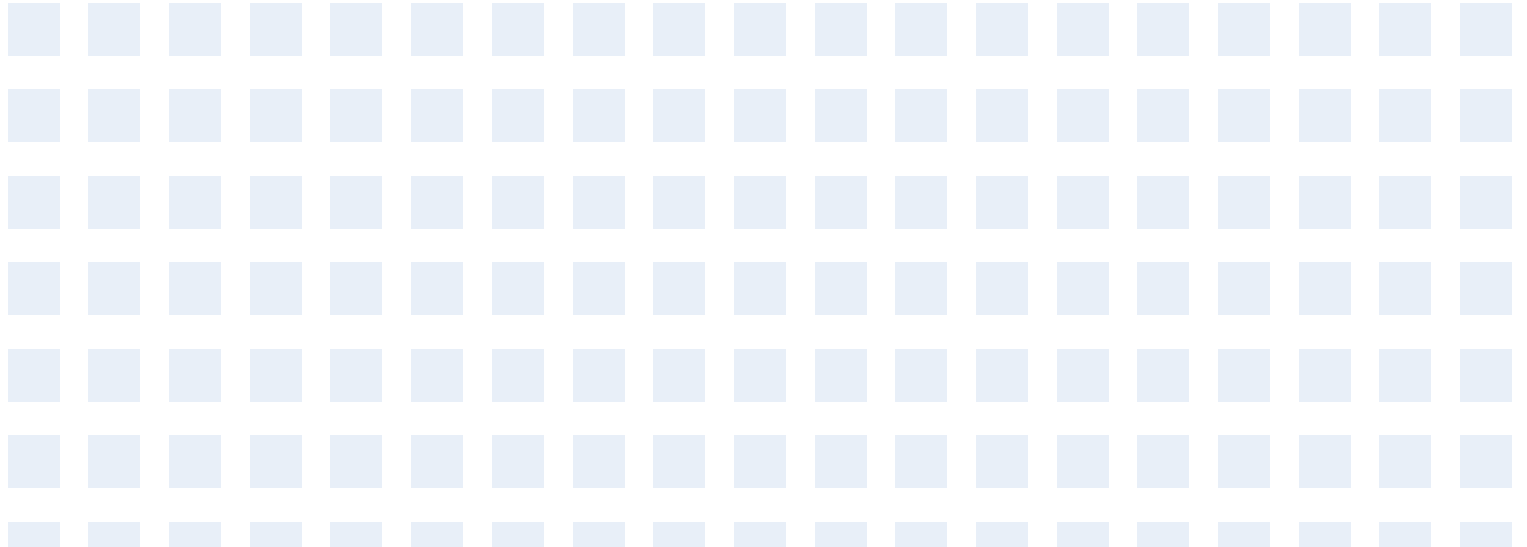

„ORIGINAL INSTRUCTIONS“

IMPORTANT NOTE:

Read this manual carefully before installing or operating your new heat pump.
Make sure to save this manual for future reference.

EN

For downloading manual for this product, please enter the model name at this link:

**DE**

Um das Handbuch für dieses Produkt herunterzuladen, geben Sie bitte den Modellnamen für diesen Link ein:

**ES**

Para descargar el manual de este producto, ingrese la designación del modelo en el siguiente enlace:

**IT**

Per scaricare il manuale di questo prodotto, inserisci il nome del modello a questo link:

**FR**

Pour télécharger le manuel de ce produit, veuillez saisir le nom du modèle sur ce lien:







CONTENTS

ACCESSORIES	01
1 INTRODUCTION	
• 1.1 use conditions of the unit	01
2 SAFETY CONSIDERATION	02
3 BEFORE INSTALLATION	
• 3.1 Handling of the unit	04
4 IMPORTANT INFORMATION ON REFRIGERANT	05
5 SELECTION OF INSTALLATION SITE	05
6 PRECAUTIONS ON INSTALLATION	
• 6.1 Outline dimensional drawing	06
• 6.2 Requirements of arrangement space of the unit	07
• 6.3 Space requirements for parallel installation of multiple Modular units	08
• 6.4 Installation foundation	08
• 6.5 Installation of damping devices	09
7 CONNECTION DRAWING OF PIPELINE SYSTEM	10
8 OVERVIEW OF THE UNIT	
• 8.1 Main parts of the unit	11
• 8.2 Opening the unit	12
• 8.3 Outdoor unit PCBs	13
• 8.4 Electric wiring	16
• 8.5 Water system installation	23
9 STRAT-UP AND CONFIGURATION	27
10 TEST RUN AND FINAL CHECK	
• 10.1 Check item table after installation	28
• 10.2 Trial run	28

11 MAINTENANCE AND UPKEEP

• 11.1 Failure information and code	29
• 11.2 Data display of wired controller	31
• 11.3 Care and maintenance	31
• 11.4 Removing scale	31
• 11.5 Winter shutdown	31
• 11.6 Replacing parts	31
• 11.7 First startup after shutdown	32
• 11.8 Refrigeration system	32
• 11.9 Disassembling compressor	32
• 11.10 Auxiliary electric heater	32
• 11.11 System antifreezing	32
• 11.12 Replacement of safety valve	33
• 11.13 Information servicing	34
RECORD TABLE OF TEST RUN AND MAINTENANCE	37
RECORD TABLE OF ROUTINE RUNNING	37
12 APPLICABLE MODELS AND MAIN PARAMETERS	38
13 INFORMATION REQUIREMENTS	39

ACCESSORIES

Unit	Installation & Operation Manual	Temperature testing components of total water outlet	Transformer	Installation manual of wired controller
Quantity	1	1	1	1
Shape				
Purpose	/	Use for installation (only need for setting the main module)		

1 INTRODUCTION

1.1 Use conditions of the unit

- 1) The standard voltage of power supply is 380-415V 3N~50Hz, the minimum allowable voltage is 342V, and the maximum voltage is 456V.
- 2) To maintain better performance, please operate the unit under the following outdoor temperature:

65KW&75KW&110KW&140KW

COOLING

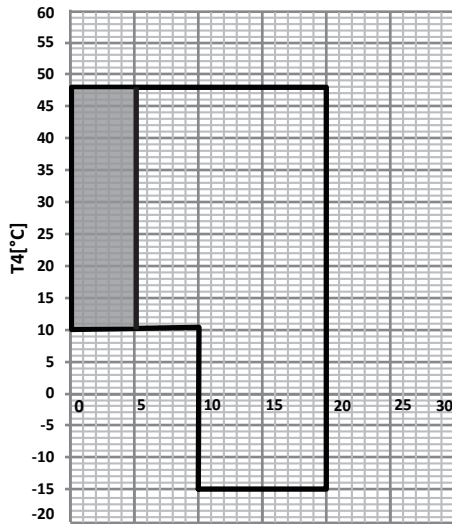

Two [°C]

Outlet water temperature (°C)

Fig. 1-1-1 Cooling operating range

65KW&75KW&110KW&140KW

HEATING

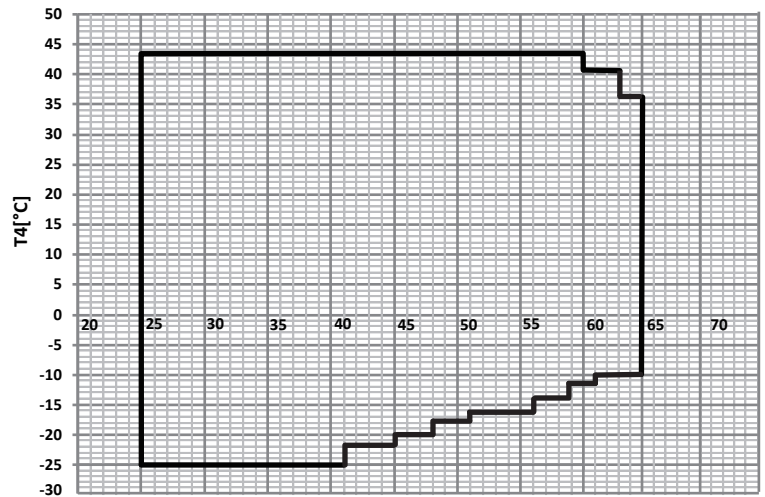

Two [°C]

Outlet water temperature (°C)

Fig. 1-1-2 Heating operating range

Low leaving water temperature mode can be set by wired controller, please refer to the Operation Manual(select "LOW OUTLETWATER CONTROL" under "SERVICE MENU" page) for details. If low leaving water temperature function is effective, the operation range will extend to the shadow area. When the setting water temperature is less than 5°C, antifreeze liquid (concentration above 15%) should be added in the water system, otherwise the unit and the water system will be damaged.

Domestic hot water mode can be set by wired controller, please refer to the Operation Manual(select "DHW SWITCH" under "USER MENU" page) for details. The outlet temperature of the heat pump can reach 62°C when it is run alone, and the outlet temperature can reach 70°C when it is paired with the electric auxiliary heating.

2. SAFETY CONSIDERATION

The precautions listed here are divided into the following types. They are quite important, so be sure to follow them carefully. Meanings of DANGER, WARNING, CAUTION and NOTE symbols.

INFORMATION

- Read these instructions carefully before installation. Keep this manual in a handy for future reference.
- Improper installation of equipment or accessories may result in electric shock, short-circuit, leakage, fire or other damage to the equipment. Be sure to only use accessories made by the supplier, which are specifically designed for the equipment and make sure to get installation done by professional installers.
- All the activities described in this manual must be carried out by a licensed technician. Be sure to wear adequate personal protection equipments such as gloves and safety glasses while installing the unit or carrying out maintenance activities.
- Contact your dealer for any further assistance.

DANGER

Indicates an imminently hazardous situation which if not avoided, will result in death or serious injury.

WARNING

Indicates a potentially hazardous situation which if not avoided, could result in death or serious injury.





CAUTION

Indicates a potentially hazardous situation which if not avoided, may result in minor or moderate injury. It is also used to alert against unsafe practices.

NOTE

Indicates situations that could only result in accidental equipment or property damage.

Explanation of symbols displayed on the indoor unit or outdoor unit

	WARNING	This symbol shows that this appliance used a flammable refrigerant. If the refrigerant is leaked and exposed to an external ignition source, there is a risk of fire.
	CAUTION	This symbol shows that the operation manual should be read carefully.
	CAUTION	This symbol shows that a service personnel should be handling this equipment with reference to the installation manual.
	CAUTION	This symbol shows that a service personnel should be handling this equipment with reference to the installation manual.
	CAUTION	This symbol shows that information is available such as the operating manual or installation manual.

DANGER

- Before touching electric terminal parts, turn off power switch.
- When service panels are removed, live parts can be easily touched by accident.
- Never leave the unit unattended during installation or servicing when the service panel is removed.
- Do not touch water pipes during and immediately after operation as the pipes may be hot and could burn your hands. To avoid injury, leave the piping drip to room temperature or be sure to wear protective gloves.
- Do not touch any switch with wet fingers. Touching a switch with wet fingers can cause electrical shock.
- Before touching electrical parts, turn off all applicable power to the unit.

⚠ WARNING

- Servicing shall only be performed as recommended by the equipment manufacturer. Maintenance and repair requiring the assistance of other skilled personnel shall be carried out under the supervision of the person competent in the use of flammable refrigerants.
- Tear apart and throw away plastic packaging bags so that children will not play with them. Children that playing with plastic bags face danger of death by suffocation.
- Safely dispose of packing materials such as nails and other metal or wood parts that could cause injuries.
- Ask your dealer or qualified personnel to perform installation work in accordance with this manual. Do not install the unit yourself. Improper installation could result in water leakage, electric shocks or fire
- Be sure to use only specified accessories and parts for installation work. Failure to use specified parts may result in water leakage, electric shocks, fire, or collapse from its mount.
- Install the unit on a foundation that can withstand its weight. Insufficient physical strength may cause the equipment to fall and possible injury.
- Perform specified installation work with full consideration of strong wind, hurricanes, or earthquakes. Improper installation work may result in accidents due to equipment falling.
- Make sure that all electrical work is carried out by qualified ersonnel according to the local laws and regulations and the manual switch should be installed individual circuit separate circuit. Insufficient capacity of the power supply circuit or improper electrical construction may lead to electric shocks or fire.
- Be sure to install a ground fault circuit interrupter according to local laws and regulations. Failure to install a ground fault circuit interrupter may cause electric shocks and fire.
- Make sure all wiring is secure. Use the specified wires and ensure that terminal connections or wires are protected from water and other adverse external forces. Incomplete connection or affixing may cause a fire.
- When wiring the power supply, tidy the wires so that the front panel can be securely fastened. If the front panel is not in place there could be overheating of the terminals, electric shocks or fire.
- After completing the installation work, make sure that there is no refrigerant leakage.
- Never directly touch any leaking refrigerant as it could cause severe frostbite. Do not touch the refrigerant pipes during or soon after operation as the refrigerant pipes may be hot or cold,. Burns or frostbite are possible if you touch the refrigerant pipes. To avoid injury, leave the pipes return to normal temperature or, wear protective gloves if you have to touch the piping.

Do not touch the internal parts (pump, backup heater, etc.) during or soon after operation. Touching the internal parts can cause burns. To avoid injury, leave the internal parts return to normal temperature or, wear protective gloves if you have to touch the piping.
- Do not accelerate the defrosting process or clean manually, unless those recommended by the manufacturer.
- The appliance shall be stored in a room without continuously operating ignition sources (for example: open flames, an operating gas appliance or an operation electric heater.)
- Do not pierce or burn the unit.
- Be aware that refrigerants may not contain an odour.



Caution: Risk of fire/
flammable materials

⚠ CAUTION

- Ground the unit.
- Grounding resistance should be according to local laws and regulations.
- Do not connect the ground wire to gas or water pipes, lightning conductors or telephone ground wires.
- Incomplete grounding may cause electric shocks.
 - Gas pipes: Fire or an explosion might occur if the gas leaks.
 - Water pipes: Hard vinyl tubes are not effective grounds.
 - Lightning conductors or telephone ground wires: Electrical threshold may rise abnormally if struck by a lightning bolt.
- Install the power wire at least 3.3 feet (1 meter) away from televisions or radios to prevent interference or noise. (Depending on the radio waves, a distance of 3.3 feet (1 meter) may not be sufficient to eliminate the noise.)
- Do not wash the unit by water. This may cause electric shocks or fire. The appliance must be installed in accordance with national wiring regulations. If the supply cord is damaged, it must be replaced.

- Do not install the unit in the following places:
 - Where there is mist of mineral oil, oil spray or vapors. Plastic parts may deteriorate, and cause possible loose or water to leak.
 - Where corrosive gases (such as sulphurous acid gas) are produced. Where corrosion of copper pipes or soldered parts may cause refrigerant leakage.
 - Where there is machinery which emits electromagnetic waves. Electromagnetic waves can disturb the control system and cause equipment malfunction.
 - Where flammable gases may leak, where carbon fiber or ignitable dust is suspended in the air or where volatile flammables such as paint thinner or gasoline are handled. These types of gases might cause a fire.
 - Where the air contains high levels of salt such as near the seaside.
 - Where voltage fluctuates a lot, such as in factories.
 - In vehicles or vessels.
 - Where acidic or alkaline vapors are present.
- Children should not play with the unit. Cleaning and user maintenance should not be done by children without supervision.
- This appliance is intended to be operated by expert or trained users in shops, in light industry and on farms, or for commercial use by lay persons
- If the supply cord is damaged, it must be replaced by the manufacturer or its service agent or a similarly qualified person in order to avoid a hazard.
- DISPOSAL: Do not dispose this product as unsorted municipal waste. Collection of such waste separately for special treatment is necessary. Do not dispose of electrical appliances as municipal waste, use separate collection facilities. Contact your local government for information regarding the collection systems available. If electrical appliances are disposed of in landfills or dumps, hazardous substance can leak into the groundwater and get into the food chain, damaging your health and well-being.
- The wiring must be performed by professional technicians in accordance with national wiring regulation and this circuit diagram. An all-pole disconnection device which has at least 3mm separation distance in all pole and a residual current device (RCD) with the rating not exceeding 30mA shall be incorporated in the fixed wiring according to the national rule.
- Confirm the safety of the installation area (walls, floors, etc.) without hidden dangers such as water, electricity, and gas before the wiring and piping works.
- Before installation , check whether the user's power supply meets the electrical installation requirements of unit (including reliable grounding , leakage , and wire diameter electrical load, etc.). If the electrical installation requirements of the product are not met, the installation of the product is prohibited until rectified.
- When installing multiple units in a centralized manner, please confirm the load balance of the three-phase power supply, and multiple units are prevented from being assembled into the same phase of the three-phase power supply.
- Product installation should be fixed firmly, Take reinforcement measures, if necessary.

NOTE

- About Fluorinated Gasses
 - This air-conditioning unit contains fluorinated gasses. For specific information on the type of gas and the amount, please refer to the relevant label on the unit itself. Compliance with national gas regulations shall be observed.
 - Installation, service, maintenance and repair of this unit must be performed by a certified technician.
 - Product uninstallation and recycling must be performed by a certified technician.
 - If the system has a leak-detection system installed, it must be checked for leaks at least every 12 months. When the unit is checked for leaks, proper record-keeping of all checks is strongly recommended.

3 BEFORE INSTALLATION

3.1 Handling of the unit

The angle of inclination should not be more than 15° when carrying the unit in case of overturn of the unit.

1) Rolling handling: several rolling rods of the same size are placed under the base of the unit, and the length of each rod must be more than the outer frame of the base and suitable for balancing of the unit.

2) Lifting: each lifting rope (belt) should be able to bear 4 times the weight of the unit. Check the lifting hook and ensure that it is firmly attached to the unit. To avoid damages to the unit, a protective block made of wood, cloth or hard paper should be placed between the unit and rope when lifting, and its thickness should be 50mm or more. It is strictly forbidden to stand under the machine when it is hoisted.

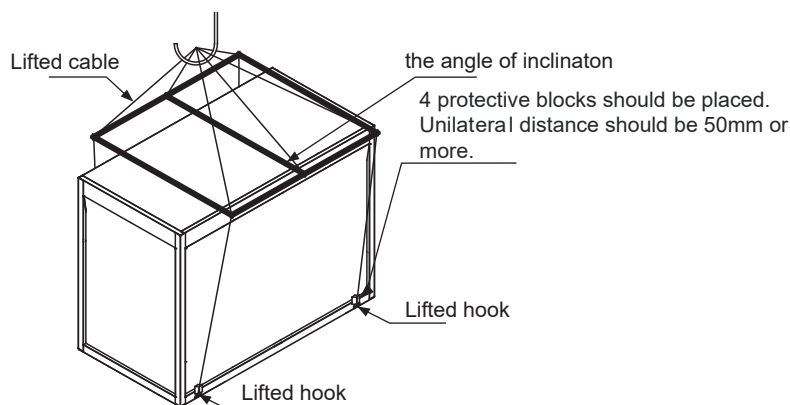

Fig. 3-1 lifting of the unit

4 IMPORTANT INFORMATION ON REFRIGERANT

This product contains fluorinated greenhouse gases covered by the Kyoto Protocol. Do not vent gases into the atmosphere.

Refrigerant type: R32

GWP value: 675

GWP : global warming potential

The refrigerant volume is indicated on the unit nameplate

- Add the refrigerant

Amount of factory-charged refrigerant and tonnes CO₂ Equivalent is

Table 4-1

Model	Refrigerant(kg)	Tonnes CO ₂ equivalent
65KW&75KW	9	6.08
110KW&140KW	15.5	10.46

5 SELECTION OF INSTALLATION SITE

- 1) Units can be installed on the ground or proper place on a roof, provided that sufficient ventilation can be guaranteed.
- 2) Do not install the unit in a scenario with requirements on noise and vibration.
- 3) When installing the unit, take measures to avoid exposure to direct sunlight, and keep the unit away from boiler pipeline and surroundings which might corrode the condenser coil and copper pipes.
- 4) If the unit can be achieved by unauthorized personnel, take protective measures for safety considerations, such as installing a fence. These measures can prevent man-caused or accidental injuries, and can also prevent the electrical parts in operation from being exposed when the main control box is opened.
- 5) Install the unit on a foundation at least 200 mm high above the ground, where the floor drain is needed, to ensure that no water accumulate.
- 6) If installing the unit on the ground, put the steel base of the unit on the concrete foundation, which must be as deep as into the solid soil layer. Ensure the installation foundation is separated from buildings, as the noises and vibration of the unit may adversely affect the latter. By means of the installation holes on the unit base, the unit can be fastened on the foundation reliability.
- 7) If the unit is installed on a roof, the roof must be strong enough to bear the weight of the unit and the weight of maintenance personnel. The unit can be placed on the concrete and groove-shaped steel frame, similar to the case when the unit is installed on the ground. The weight-bearing groove-shaped steel must match the installation holes of the shock absorber and is wide enough to accommodate the shock absorber.
- 8) For other special requirements for installation, please consult the building contractor, architectural designer or other professionals.

NOTE

The selected installation site of the unit should facilitate connection of water pipes and wires, and be free from water inlet of oil fume, steam or other heat sources. Besides, the noise of the unit and discharge air should not influence the surrounding environment.

6 PRECAUTIONS ON INSTALLATION

6.1 Outline dimensional drawing

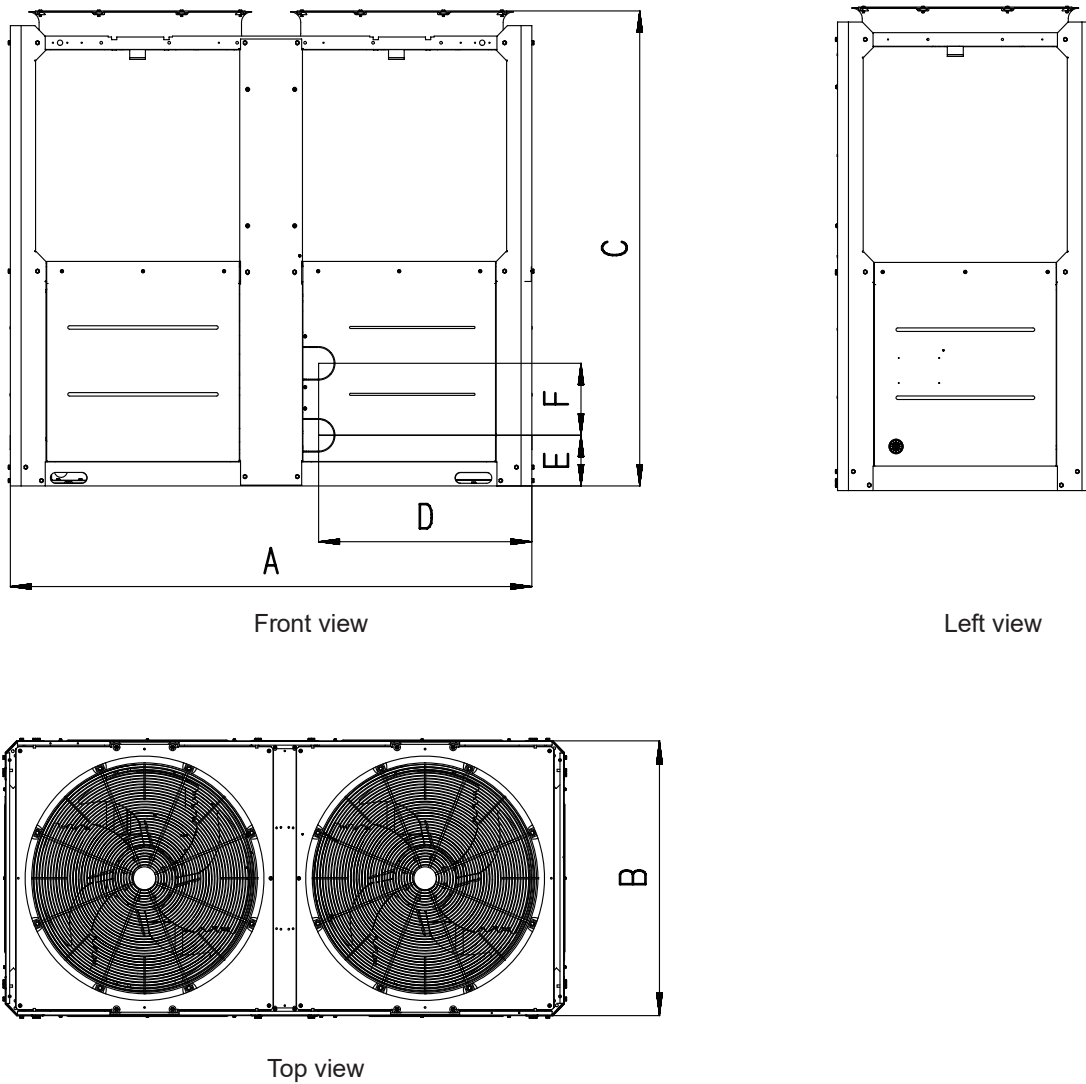

Fig. 6-1 Outline dimensional

Table 6-1

Model	65KW&75KW	110KW&140KW
A	2000	2220
B	960	1135
C	1770	2300
D	816	910
E	190	155
F	269	300

NOTE

After installing the spring damper, the total height of the unit will increase by 135mm approximately.

6.2 Requirements of arrangement space of the unit

- 1) To ensure adequate airflow entering the condenser, the influence of descending airflow caused by the high-rise buildings around upon the unit should be taken into account when installing the unit.
- 2) If the unit is installed where the flowing speed of air is high, such as on the exposed roof, the measures including sunk fence and Persian blinds can be taken, to prevent the turbulent flow from disturbing the air entering the unit. If the unit needs to be provided with sunk fence, the height of the latter should not be more than that of the former; if Persian blinds are required, the total loss of static pressure should be less than the static pressure outside the fan. The space between the unit and sunk fence or Persian blinds should also meet the requirement
- 3) If the unit needs to operate in winter, and the installation site may be covered by snow, the unit should be located higher than the snow surface, to ensure that air flows through the coils smoothly.

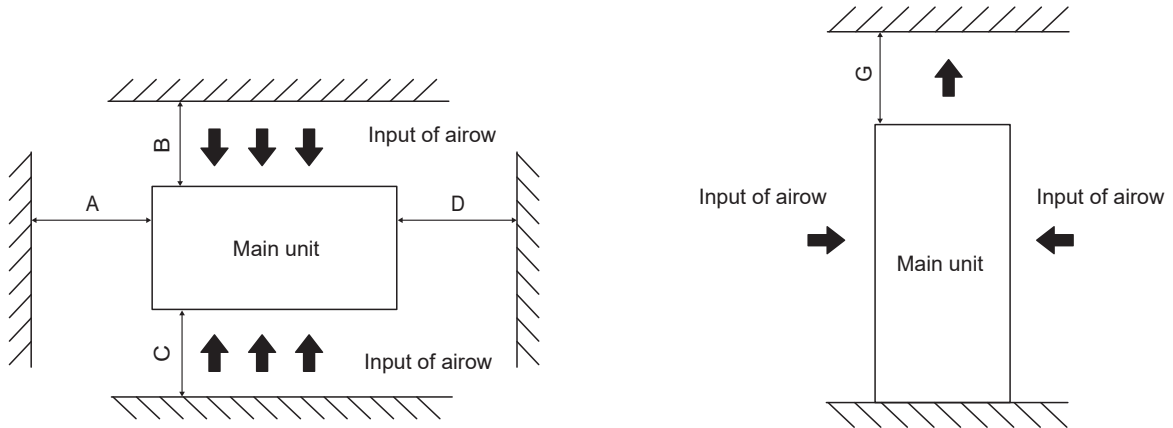

Fig. 6-2 single unit installstion

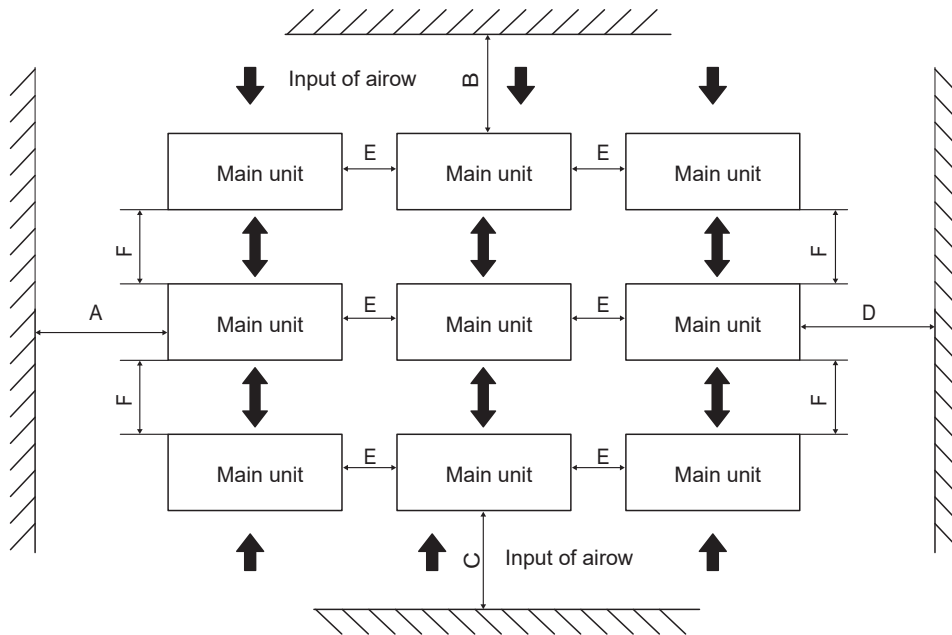

Fig. 6-3 multiple units installstion

Table 6-2

Installation space (mm)			
A	≥1500	E	≥800
B	≥1500	F	≥1100
C	≥1500	G	≥3000
D	≥1500	/	/

WARNING

When the number of units installed in the same place is greater than 40 units, please contact professionals to confirm the installation method.

6.3 Installation foundation

6.3.1 Base structure

Outdoor unit base structure design should take account of the following considerations:

- 1) A solid base prevents excess vibration and noise. Outdoor unit bases should be constructed on solid ground or on structures of sufficient strength to support the units' weight.
- 2) Bases should be at least 200mm high to provide sufficient access for installation of piping. Snow protection should also be considered for the base height.
- 3) Either steel or concrete bases may be suitable.
- 4) A typical concrete base design is shown in Fig. 6-4. A typical concrete specification is 1 part cement, 2 parts sand and 4 parts crushed stone with steel reinforcing bar. The edges of the base should be chamfered.
- 5) To ensure that all contact points are equally secure, bases should be completely level. Base design should ensure that the points on the units' bases designed for weight-bearing support are fully supported.

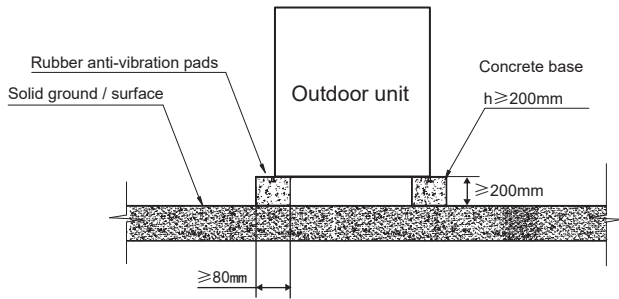

Fig. 6-4 Front view of base structure

6.3.2 Location drawing of installation foundation of the unit: (unit: mm)

- 1) If the unit is located so high that it is inconvenient for maintenance personnel to conduct maintenance, the suitable scaffold can be provided around the unit.
- 2) The scaffold must be able to bear the weight of maintenance personnel and maintenance facilities.
- 3) The bottom frame of the unit is not allowed to be embedded into the concrete of installation foundation.
- 4) A drainage ditch should be provided to allow drainage of condensate that may form on the heat exchangers when the units are running in heating mode. The drainage should ensure that condensate is directed away from roadways and footpaths, especially in locations where the climate is such that condensate may freeze.

(unit: mm)

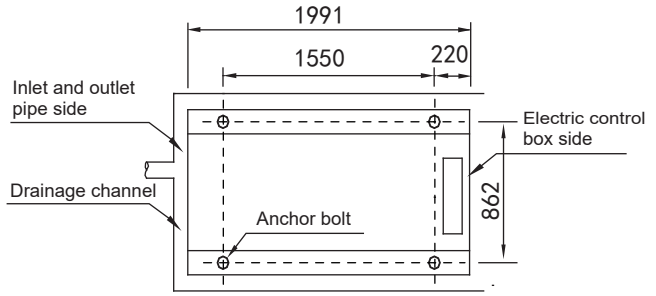

Fig. 6-5 Top view of schematic diagram of installation dimension of 65KW&75KW

(unit: mm)

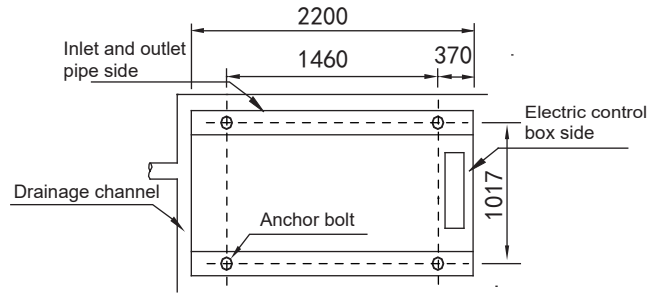

Fig. 6-6 Top view of schematic diagram of installation dimension of 110KW&140KW

6.4 Installation of damping devices

6.4.1 Damping devices must be provided between the unit and its foundation.

By means of the $\Phi 15\text{mm}$ diameter installation holes on the steel frame of the unit base, the unit can be fastened on the foundation through the spring damper. See Fig. 6-5, 6-6 (Schematic diagram of installation dimension of the unit) for details about center distance of the installation holes. The damper does not go with the unit, and the user can select the damper according to the relevant requirements. When the unit is installed on the high roof or the area sensitive to vibration, please consult the relevant persons before selecting the damper.

6.4.2 Installation steps of the damper

Step 1. Make sure that the flatness of the concrete foundation is within $\pm 3\text{mm}$, and then place the unit on the cushion block.

Step 2. Raise the unit to the height suitable for installation of the damping device.

Step 3. Remove the clamp nuts of the damper. Place the unit on the damper, and align the fixing bolt holes of the damper with the fixing holes on the unit base.

Step 4. Return the clamp nuts of the damper to the fixing holes on the unit base, and tighten them into the damper.

Step 5. Adjust the operational height of the damper base, and screw down the leveling bolts. Tighten the bolts by one circle to ensure equal height adjustment variance of the damper.

Step 6. The lock bolts can be tightened after the correct operational height is reached.

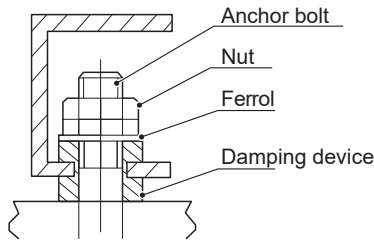
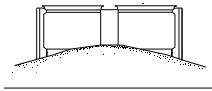

Fig. 6-7 Installation of the damper

6.5 Installation of device to prevent snow build-up and strong breeze

When installing an air-cooled heat pump chiller in a place with heavy snow, it is necessary to take snow protection measures to ensure trouble-free operation of the equipment. Otherwise, accumulated snow will block the air flow and may cause equipment problems.

(a) Buried in the snow



(b) Snow accumulated on the top plate

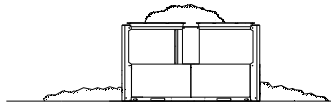

(c) Snow falling on the equipment

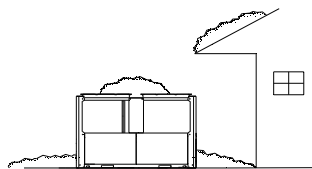

(d) Air inlet blocked by snow

wind with snow

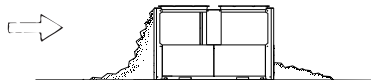

(e) Equipment covered with snow

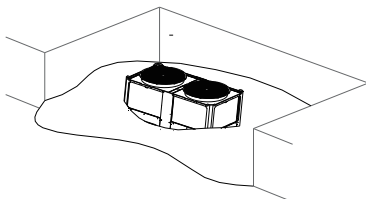

Fig. 6-8 Types of problems caused by snow

6.5.1 Measures used to prevent problems caused by snow

1) Measures to prevent build-up of snow

The base height should be as least the same as the predicted snow depth in the local area.

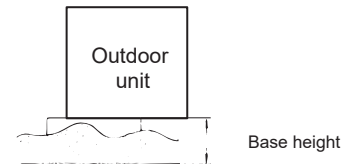

Fig. 6-9 Snow prevention base height

2) Lightning protection and snow protection measures

Check the installation site thoroughly; do not install the equipment under awnings or trees or a place where snow is piled up.

6.5.2 Precautions for designing a snow cover

1) To ensure a sufficient air flow required by the air-cooled heat pump chiller, design a protective cover to make the dust resistance 1 mm H₂O or less lower than the allowable external static pressure of air-cooled heat pump chiller.

2) The protective cover must be strong enough to withstand the snow weight and the pressure caused by strong wind and typhoon.

3) The protective cover must not cause short circuit of air discharge and suction.

7 CONNECTION DRAWING OF PIPELINE SYSTEM

This is the water system of standard module.

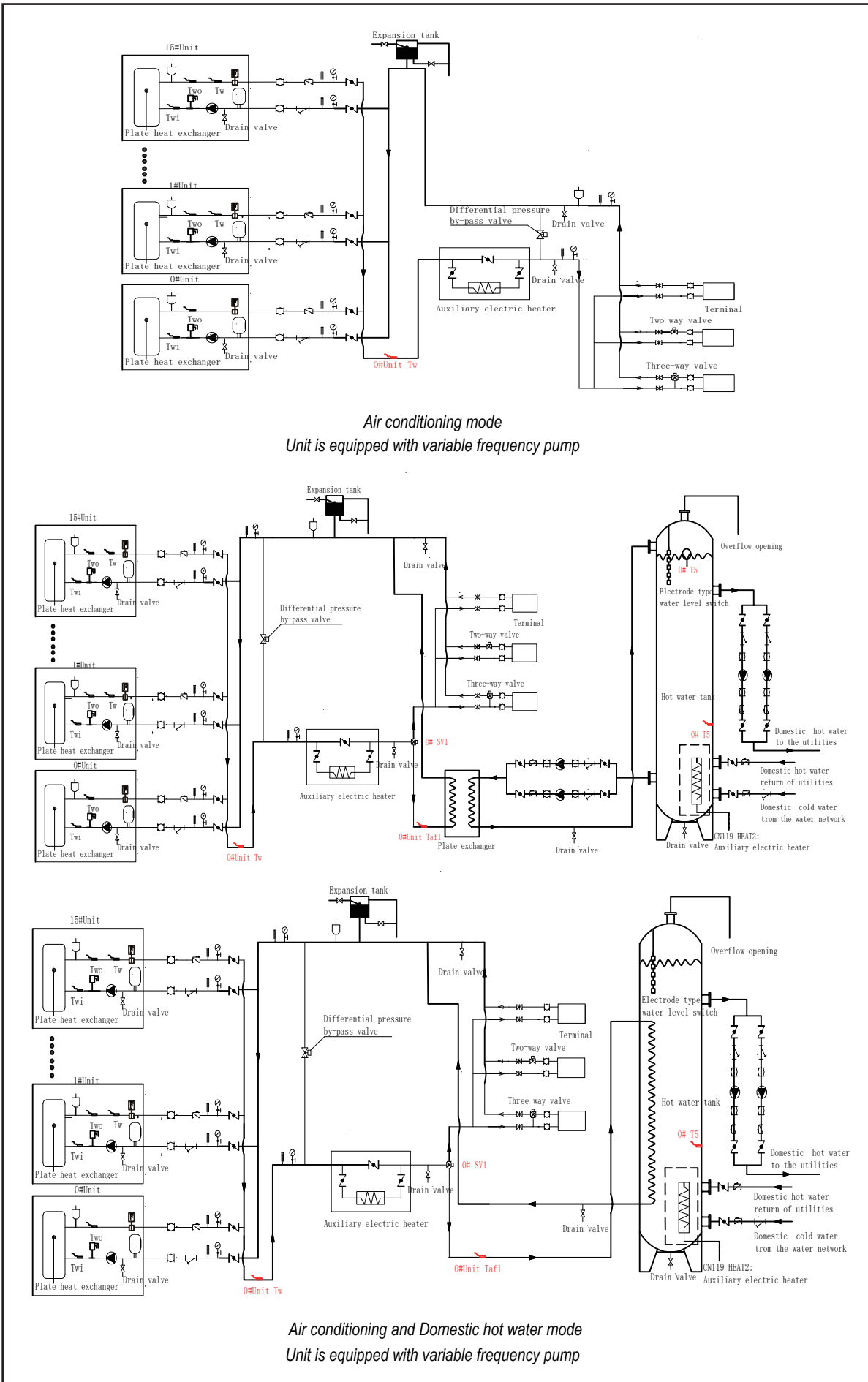















Symbol explanation					
	Drain vavle		Water pressure instrument		Water flow switch
	Y-filter		Thermometer		Pump
	Expansion tank		Safety valve		Soft joint
					Gate valve
					Check valve
					Solenoid three-way valve
					Differential pressure by-pass valve
					Atmospheric exhaust valve

Fig.7-1 Connection drawing of pipeline system

NOTE

- The ratio of the two - way valves on the terminal shall not exceed 50 percent.
- The main outlet water temperature sensing (Tw) head of the unit at address 0 needs to be placed on the main outlet pipe.
- The hot water tank and the hot water exchange pump of the unit use the CN125 (220V) port control switch on the slave board of the 0 # unit, pump output is controlled through CN108 (0-10V).
- The electronic butterfly valve on the unit water outlet pipe is controlled by the CN123 port on the slave board of each unit.

8 OVERVIEW OF THE UNIT

8.1 Main parts of the unit

Table 8-1

NO.	NAME	NO.	NAME
1	Air outlet	6	Condenser
2	Top cover	7	Water outlet
3	Electric control box	8	Air inlet
4	Compressor	9	Water inlet
5	Evaporator	10	wire controller (It can be placed indoors)

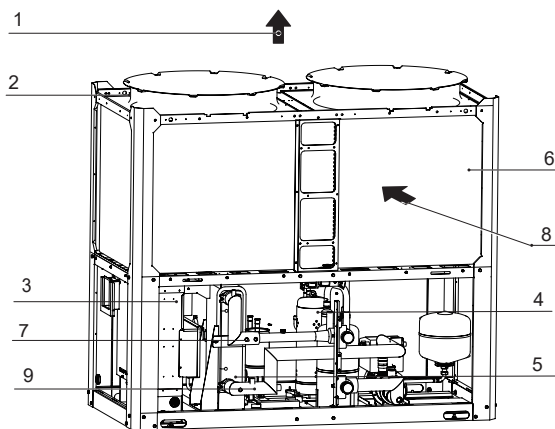

Fig. 8-1 Main parts of 65KW&75KW

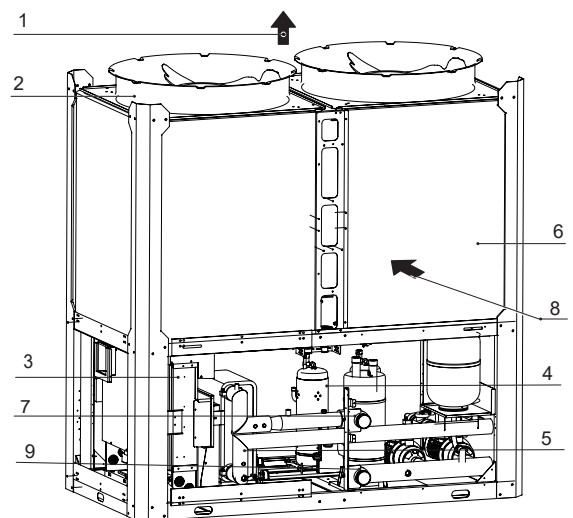

Fig. 8-2 Main parts of 110KW&140KW

8.2 Opening the unit

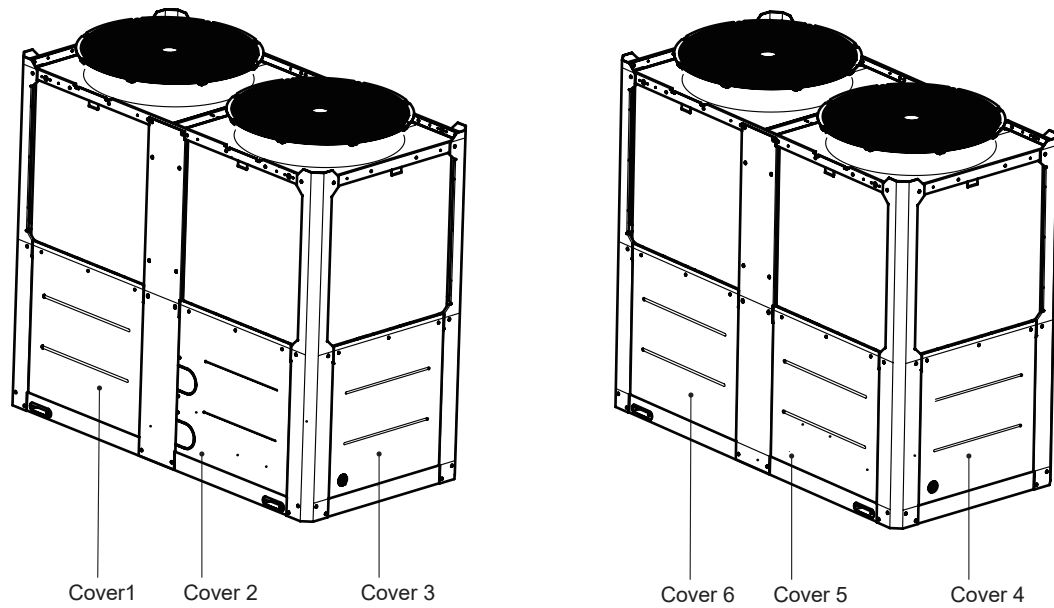

Fig. 8-3 Doors of 65KW&75KW

Cover 1/2/3 give access to the compartment of water pipes and water side heat exchanger.

Cover 4 give access to the electrical parts.

Cover 5/6 give access to the hydraulic compartment.

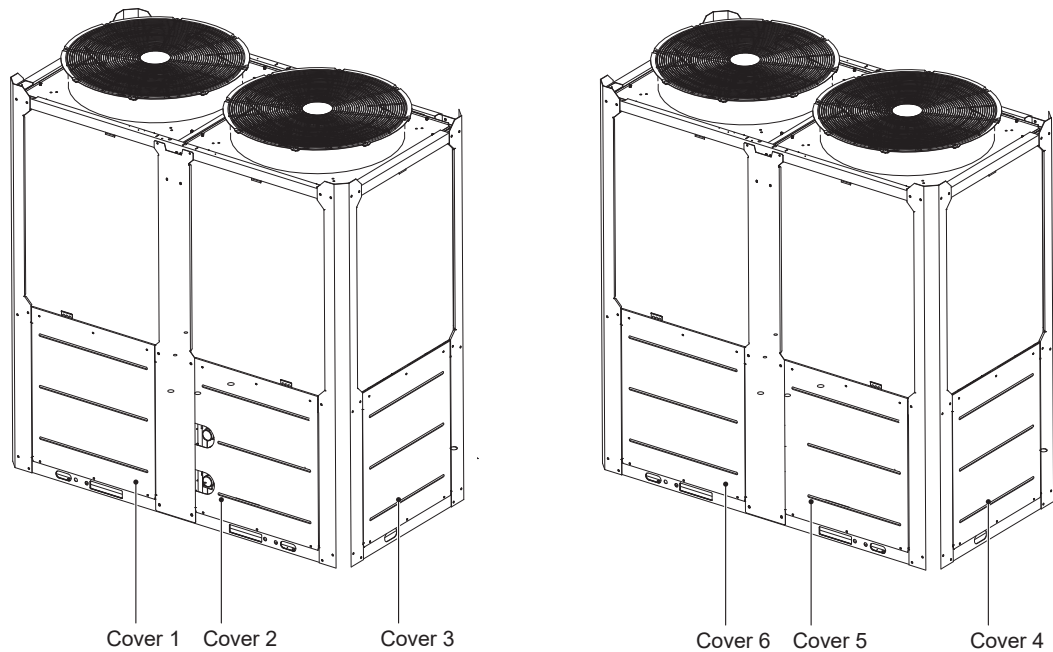

Fig. 8-4 Doors of 110KW&140KW

Cover 1/2/3 give access to the compartment of water pipes and water side heat exchanger.

Cover 4 give access to the electrical parts.

Cover 5/6 give access to the hydraulic compartment.

8.3 Outdoor unit PCBs

8.3.1 MAIN PCB

1) Label descriptions are given in Table 8-2

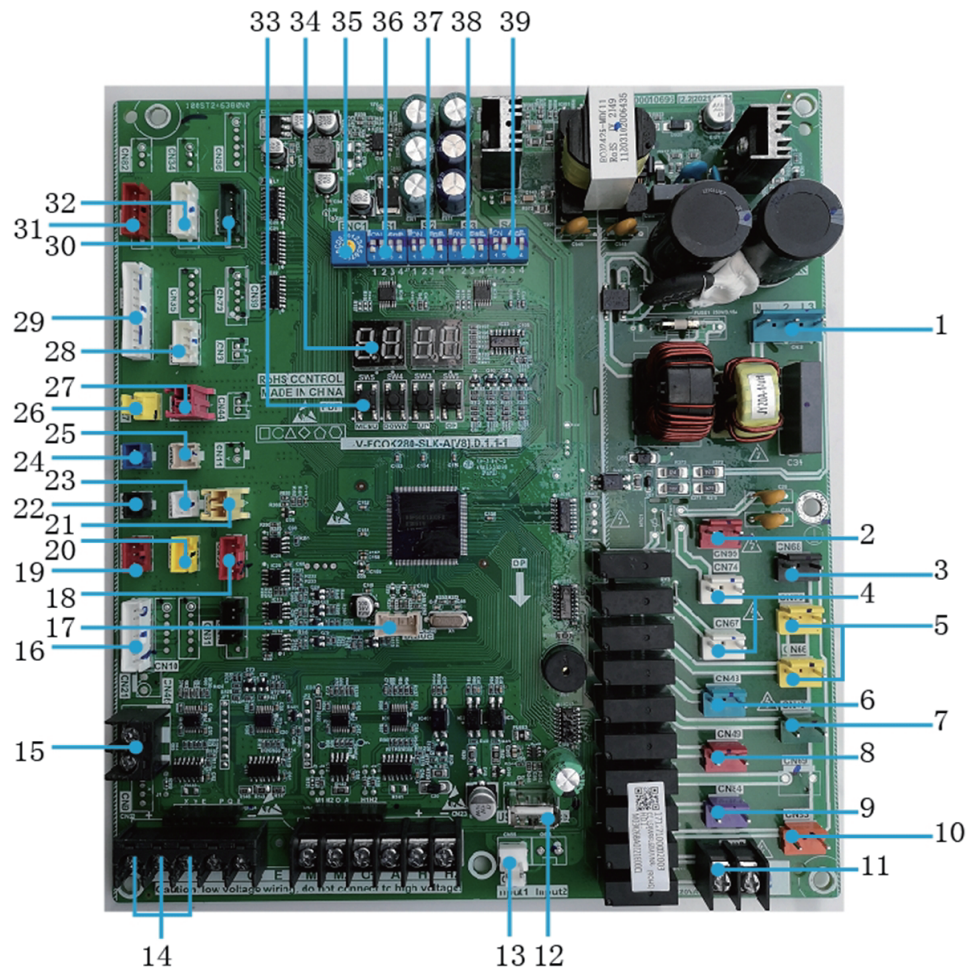

Fig. 8-5 Main board of 65KW&75KW&110KW&140KW

Table 8-2

NO.	Detail information
1	CN32: Main board power supply.
2	CN99:slave board power supply.
3	CN68:Pump(220-240V control power supply) 1) After receiving start-up instruction, the pump will be started up instantly, and will maintain start-up state always in the process of operation. 2) In case of refrigerating or heating shutdown, the pump will be shut down 2 minutes after all modules stop operating. 3) In case of shutdown under the pump mode, the pump can be directly shut down.
4	CN74/CN67:CCH,Crankcase heater
5	CN75/CN66:EVA-HEAT,Electric of water side heat exchanger heaters connection
6	CN6:ST1,Four-way valve
7	CN49:SV6,Liquid bypass solenoid valve
8	CN69:SV5,Multi-function solenoid valve
9	CN84:SV8A,Injection solenoid valve of compressor system A
10	CN83:SV8B,Injection solenoid valve of compressor system B
11	CN93: The alarm signal output of the unit(ON/OFF signal) Attention: the control port value of the pump actually detected is ON/OFF but not 220-230V control power supply , so special attention should be paid when installing the alarm signal output.

NO.	Detail information
12	CN18:Program burn in port(USB).
13	CN28:Three-phase protector output switch.(Protection code E8)
14	CN22:Outdoor units communication and wired controller communication port
15	CN46:The power supply port of the wired controller (DC12V)
16	CN26: Compressor inverter module and Fan inverter module communication ports
17	CN300:Program burn in port(WizPro200RS programming device).
18	CN109:Communicate with slave board
19	CN41:System low pressure sensor
20	CN40:System high pressure sensor
21	CN45:Taf2:Water side antifreeze temperature sensor
22	CN37:T3A:pipe temperature sensor of the condenser
23	CN30:T4: outdoor ambient temperature sensor
24	CN16:T3B:pipe temperature sensor of the condenser
25	CN38:Tp2:DC inverter compressor B discharge temperature sensor
26	CN20:TP-PRO,Discharge temperature switch protection (protection code P0,provent the compressor from over temperature 115 C)
27	CN19:Low voltage protection switch.(Protection code P1)
28	CN16: T6A:Refrigerant inlet temperature of EVI plate heat exchanger T6B:Refrigerant outlet temperature of EVI plate heat exchanger
29	CN4:Temperature sensors input port Twi:Unit water inlet temperature sensor Th:System suction temperature sensor Two:Unit water outlet temperature sensor Tz/7:coil final outlet temperature sensor Tp1:DC inverter compressor A discharge temperature sensor
30	CN72:EXVC,EVI electronic expansion valve.Used for EVI.
31	CN70:EXVA,System electronic expansion valve1.
32	CN71:EXVB,System electronic expansion valve2.Used for cooling.
33	SW3:Up button a) Select different menus when enter menu selection. b) For sopt inspection in conditions. SW4:Down button a) Select different menus when enter menu selection. b) For sopt inspection in conditions. SW5:Menu button Press to enter menu selection, short press to return to the previous menu. SW6:OK button Enter the submenu or confirm the function selected by short pressing.
34	Digital tube 1) In case of stand-by, the address of the module is displayed; 2) In case of normal operation, 10. is displayed (10 is followed by dot). 3) In case of fault or protection, fault code or protection code is displayed.
35	ENC1:NET_ADDRESS DIP switch 0-F of outdoor unit network address is enabled, which represent address 0-15.
36	S1:Dip switch S1-1:Normal control, valid for S1-1 OFF(factory default). Remote control, valid for S1-1 ON. S1-2:Normal outlet water temperature valid for S1-2 OFF. High outlet water temperature ,valid for S1-2 ON(factory default). S1-3:Single water pump controll, valid for S1-3 OFF (factory default) Multiple water pumps control, valid for S1-3 ON. S1-4:Single variable frequency pump control of unit valid for S1-4 OFF (factory default) Frequency conversion pump plus constant frequency pump control of unit valid for S1-4 ON.
37	S2:Dip switch(reserve)
38	S3:Dip switch S3-1:Valid for S3-1 ON (factory default).
39	S4:POWER DIP switch for capacity selection. (65KW defaults 0010, 75KW defaults 0011,110KW defaults 0101,140KW defaults 0111.)

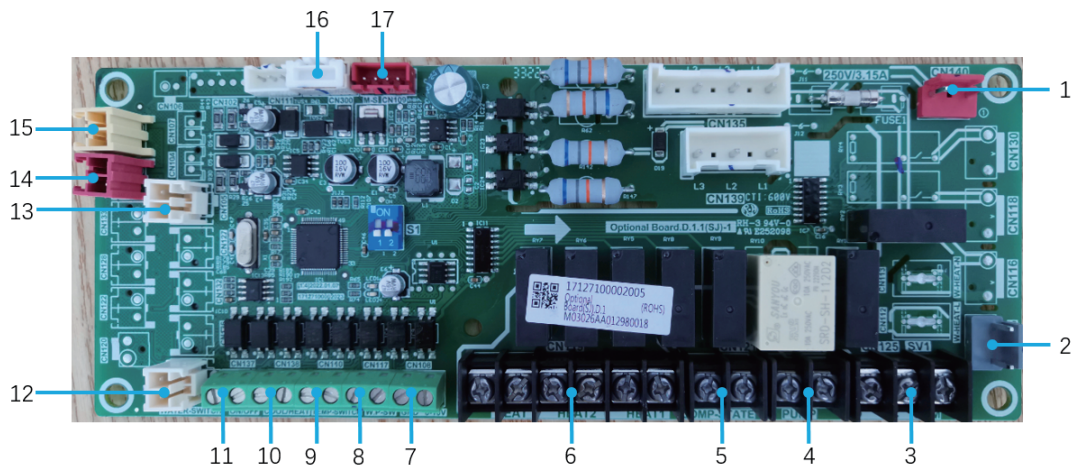

Fig. 8-6 Slave board of 65KW&75KW&110KW&140KW

Table 8-3

NO.	Detail information
1	CN140:Power supply,220-240VAC input
2	CN115:W-HEAT,Electric heater of water flow switch
3	CN125:Three-way valve(hot-water valve)
4	CN123:Pump(220-240V control power supply) 1) After receiving start-up instruction, the pump will be started up instantly, and will maintain start-up state always in the process of operation. 2) In case of refrigerating or heating shutdown, the pump will be shut down 2 minutes after all modules stop operating. 3) In case of shutdown under the pump mode, the pump can be directly shut down. 4) When the frequency conversion pump plus constant frequency pump control of unit valid for S1-4 ON , CN123 controls the start and stop of the constant frequency pump.
5	CN121:COMP-STATE,connect with an ac light to indicate the state of the compressor Attention: the control port value of the pump actually detected is ON/OFF but not 220-240V control power supply , so special attention should be paid when installing the light.
6	CN119: HEAT1.Pipeline Auxiliary Heater HEAT2.Hot Water Tank Auxiliary Heater Attention: the control port value of the pump actually detected is ON/OFF but not 220-240V control power supply , so special attention should be paid when installing the pipeline auxiliary heater.
7	CN108:Inverter pump 0-10V output control signal
8	CN109:W.P-SW,Water pressure switching port.
9	CN110:TEMP-SW,Target water temperature switching port.
10	CN138:Remote function of cool/heat signal
11	CN137:Remote function of on/off signal
12	CN114:Water flow switch signal
13	CN105:Taf1:Water side antifreeze temperature
14	CN101:Tw:Total water outlet temperature sensor when several units are connected in parallel
15	CN103:T5:Water tank temperature sensor
16	CN300:Program burn in port(WizPro200RS programming device).
17	CN109:Communicate with main board

CAUTION

• Faults

When the main unit suffers faults, the main unit stops operating, and all other units also stop running;
 When the subordinate unit suffers faults, only the unit stops operating, and other units are not affected.

• Protection

When the main unit is under protection, only the unit stops operating, and other units keep running;
 When the subordinate unit is under protection, only the unit stops operating, and other units are not affected.

8.4 Electric wiring

8.4.1 Electric wiring

⚠ CAUTION

- The air-conditioner should apply special power supply, whose voltage should conform to rated voltage.
- Wiring construction must be conducted by the professional technicians according to the labeling on the circuit diagram.
- The power wire and the grounding wire must be connected to the suitable terminals.
- The power wire and the grounding wire must be fasten up by suitable tools.
- The terminals connected the power wire and the grounding wire must be fully fastened and regularly checked, in case to become loose.
- Only use the electric components specified by our company, and require installation and technical services from the manufacturer or authorized dealer. If wiring connection doesn't conform to electric installation specification, it may cause many troubles like failure on controller, electronic shock and so on.
- The connected fixed wires must be equipped with full switching-off devices with at least 3mm contact separation.
- Set leakage protective devices according to the requirements of national technical standard about electric equipment.
- After completing all wiring construction, conduct careful check before connecting the power supply.
- Please carefully read the labels on the electric cabinet.
- Please don't repair the controller by yourself, since improper operation may cause electric shock, damages to the controller and other bad results. If the unit need repair, please contact the maintenance center., since improper repair may cause electric shock, damages to the controller, and so on. If the user has any requirement of repair, please contact the maintenance center.
- The power cord type designation is H07RN-F.

8.4.2 65KW,75kw,110KW and 140KW

DIP switch, buttons and digital display positions of units.

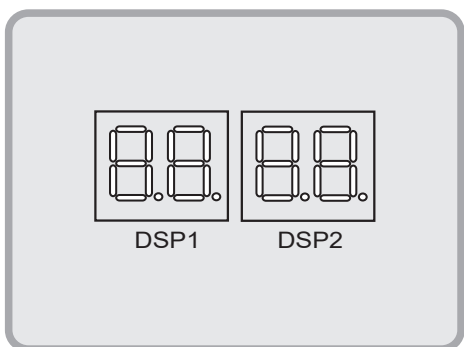
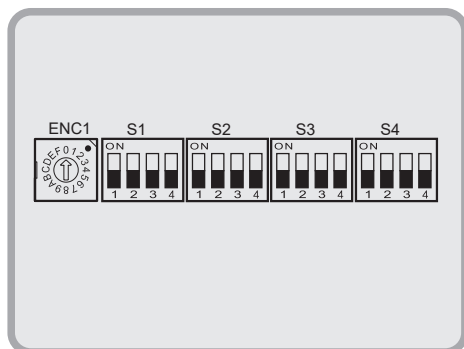

Fig. 8-7 Display positions

8.4.3 DIP switch instructions

Table 8-4 C

ENC1		0-F	0-F valid for unit address setting on the DIP switches 0 indicates the master unit and 1-F the auxiliary units (parallel connection) (0 by default)
S1-1		OFF	Normal control Valid for S1-1 OFF(factory default)
		ON	Remote control valid for S1-1 ON
S1-2		OFF	Normal outlet water temperature Valid for S1-2 OFF
		ON	High outlet water temperature valid for S1-2 ON(factory default)
S1-3		OFF	Single water pump control Valid for S1-3 OFF
		ON	Multiple water pumps control Valid for S1-3 ON (factory default)
S1-4		OFF	Single variable frequency pump control of unit valid for S1-4 OFF (65KW & 75KW)
		ON	Frequency conversion pump plus constant frequency pump control of unit valid for S1-4 ON. (110KW & 140KW)
S3-1		ON	Valid for S3-1 ON(factory default)
S4		0010	DIP switch for capacity selection (65KW defaults 0010)
		0011	DIP switch for capacity selection (75KW defaults 0011)

8.4.4 Electrical wiring precautions

a. On-site wiring, parts and materials must comply with the local and national regulations as well as relevant national electrical standards.

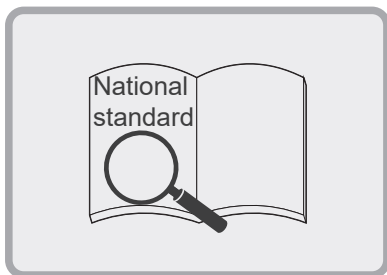

Fig. 8-8-1 Electrical wiring precaution (a)

b. Copper core wires must be used

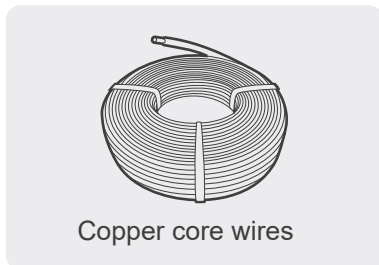

Fig. 8-8-2 Electrical wiring precaution (b)

S4		0101	DIP switch for capacity selection (110KW defaults 0101)
		0111	DIP switch for capacity selection (140KW defaults 0111)

c. It is advisable to use 3-core shielded cables for unit to minimize interference. Do not use the unshielded multicore conductor cables.



Fig. 8-8-3 Electrical wiring precaution (c)

d. Power wiring must be entrusted to professionals with electrician qualification.

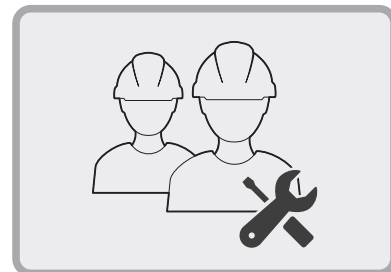

Fig. 8-8-4 Electrical wiring precaution (d)

8.4.5 Power supply specification

Table 8-5

Item Model	Outdoor power supply			
	Power supply	Manual switch	Fuse	Wiring
65KW&75KW	380-415V/3N~50Hz	100A	63A	16mm ² X5(<20m)
110KW&140KW	380-415V/3N~50Hz	200A	150A	50mm ² X5(<20m)

NOTE

- See the table above for power wire diameter and length when the voltage drop at the power wiring point is within 2%. If the wire length exceeds the value specified in the table or the voltage drop is beyond the limit, the power wire diameter should be larger in accordance with the relevant regulations.

8.4.6 Requirements for power supply wiring

○ Correct

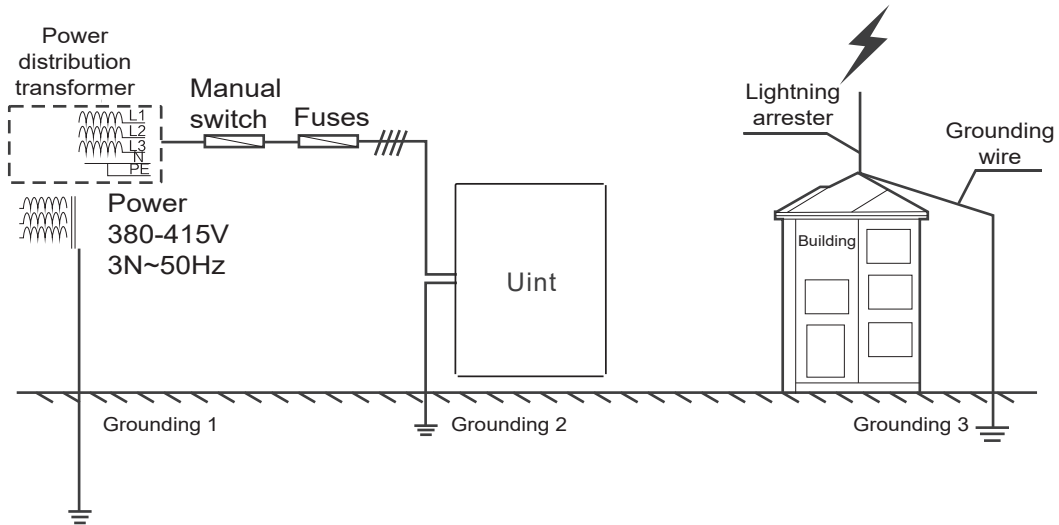

✗ Wrong

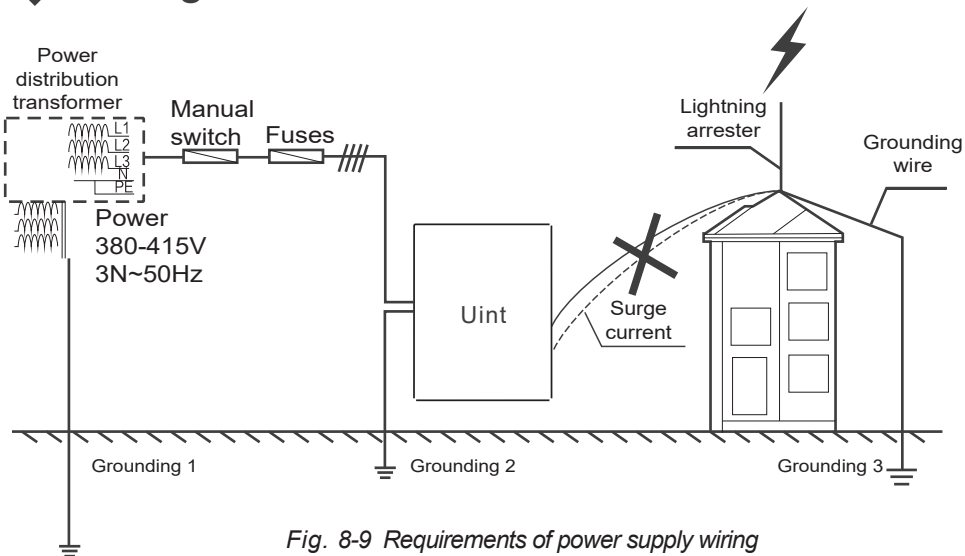

Fig. 8-9 Requirements of power supply wiring

NOTE

- Do not connect the grounding wire of the lightning arrester to the unit shell. The grounding wire of the lightning arrester and the power supply grounding wire must be configured separately.

8.4.7 Requirements for power cord connection

○ Correct

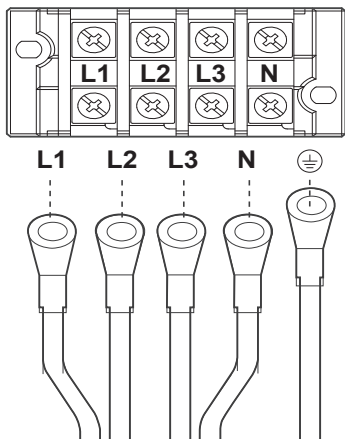

✗ Wrong

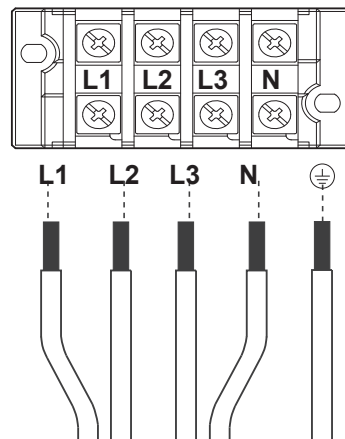

Fig. 8-10 Requirements for power cord connection

NOTE

Please use the round-type terminal with correct specifications to connect the power cord.

8.4.8 Function of terminals

As shown in the figure below, For 65KW,75KW,110KW and 140KW,the unit communication signal wire and the wired controller signal wire is connected to the terminal block CN22 at XYE on main board inside the electric control box. For specific wiring, see chapter 8.4.14.

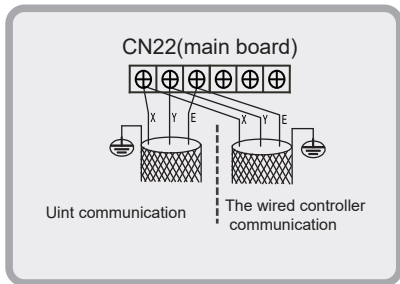

When the auxiliary heater are added externally, a 3-phase contactor must be used for control. The model of contactor is subject to the power of heater power. The contactor coil is controlled by the main control board.

See the figure below for coil wiring. For specific wiring, see chapter 8.4.14 .

The user can connect an ac light to monitor the state of compressor. When the compressor is operating, the light will be powered on.

The wiring of pipeline auxiliary heater and ac light of the state of compressor is as follows.

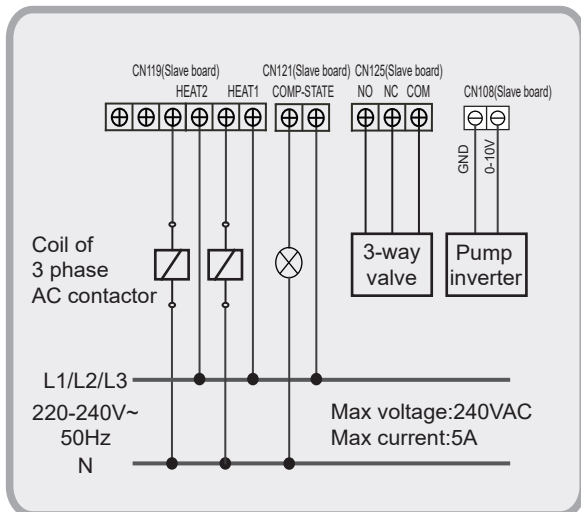

Fig. 8-11 Wiring of pipeline auxiliary heater and ac light of the state of compressor(65KW,75KW,110KW and 140KW)

8.4.9 Wiring of “ON/OFF” weak electric port

The remote function of “ON/OFF” must be set by DIP switch .The remote function of “ON/OFF” is effective when S1-1 or S5-3 is chosen ON, at the same time, the wired controller is out of control. Corresponding parallel connect the “ON/OFF” port of the main unit’s electric control box, then, connect the “ON/OFF” signal (provide by user) to the “ON/OFF” port of main unit as follows. The remote function of “ON/OFF” must be DIP switch set.

Wiring method:

For 65KW,75KW,110KW and 140KW:Shorting the terminal block CN138 at slave board inside the electric control box to enable the remote function of “ON/OFF” .

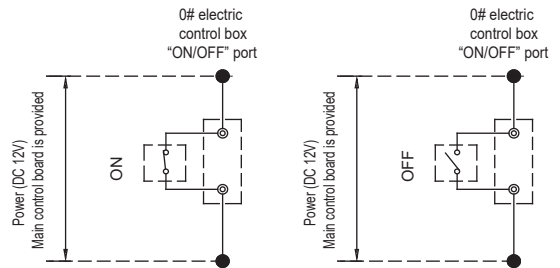

Fig. 8-12 Wiring of “ON/OFF” weak electric port

8.4.10 Wiring of “HEAT/COOL” weak electric port

The remote function of “HEAT/COOL” must be set by DIP switch. The remote function “HEAT/COOL” is effective when S1-1or S5-3 is chosen ON, at the same time, the wire controller is out of control.

Corresponding parallel connect the “HEAT/COOL” port of the main unit’s electric control box, then, connect the “ON/OFF” signal (provide by user) to the “HEAT/COOL” port of main unit as follows.

Wiring method:

For 65KW,75KW,110KW and 140KW:Shorting the terminal block CN138 at slave board inside the electric control box to enable the remote function of “HEAT/COOL” .

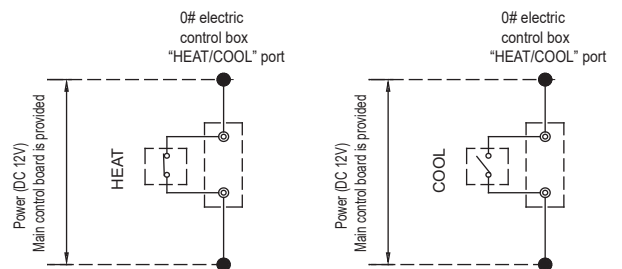

Fig. 8-13 Wiring of “HEAT/ COOL” weak electric port

8.4.11 Wiring of “TEMP-SWITCH” weak electric port

The function of “TEMP-SWITCH” must be set by wired controller for two setting water temperature. For cooling and heating mode. Wiring method:

For 65KW,75KW,110KW and 140KW: Shorting the terminal block CN110 at slave board inside the electric control box to chose the target water temperature

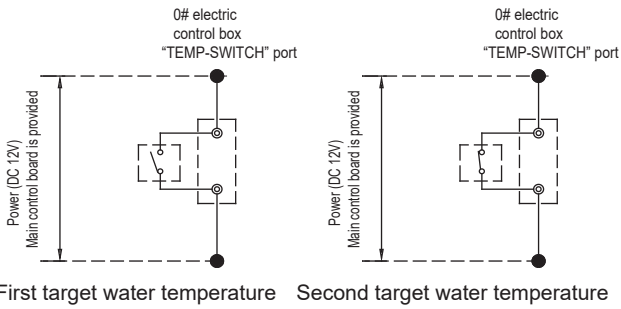

Fig. 8-14 Wiring of “TEMP-SWITCH” weak electric port

8.4.12 Wiring of “ALARM” port

Connect the device provided by user to the “ALARM” ports of the module units as follows.

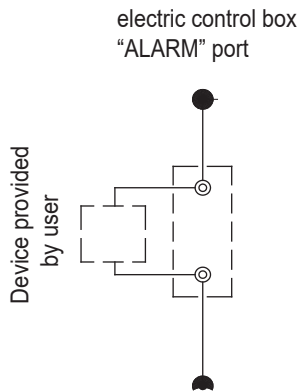

Fig. 8-15 Wiring of “ALARM” port

If the unit is operating unnormally,the ALARM port is closed, otherwise,the ALARM port is open. The ALARM ports are on the main control board. See the wiring diagram for details.

8.4.13 Control system and installation precautions

a. Use only shielded wires as control wires. Any other type of wires may produce a signal interference that will cause the units to malfunction.



Fig. 8-16-1 Control system and installation precaution (a)

b. The shielding nets at both ends of the shielded wire must be grounded. Alternatively, the shielding nets of all shielded wires are interconnected and then connected to earth through one metal plate.

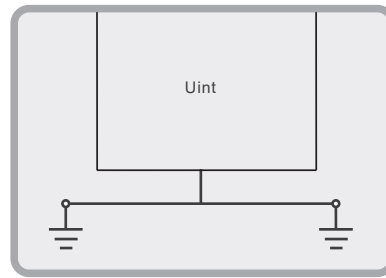

Fig. 8-16-2 Control system and installation precaution (b)

c. Do not bind the control wire, refrigerant piping and power cord together. When the power cord and control wire are laid parallel, they should be kept at a distance of more than 300 mm to prevent signal source interference.

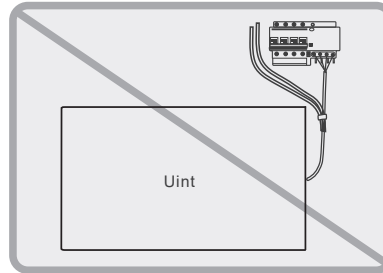

Fig. 8-16-3 Control system and installation precaution (c)

d. Pay attention to the polarity of the control wire when conducting wiring operations.

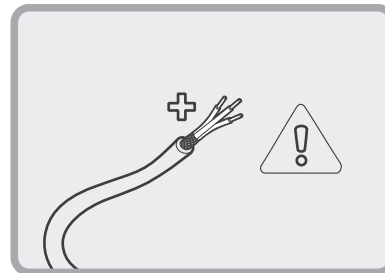

Fig. 8-16-4 Control system and installation precaution (d)

8.4.14 Wiring instances

If multiple units are connected in cascade, the unit address should be set on the DIP switch ENC1. With 0-F being valid, 0 indicates the master unit and 1-F indicate slave units.

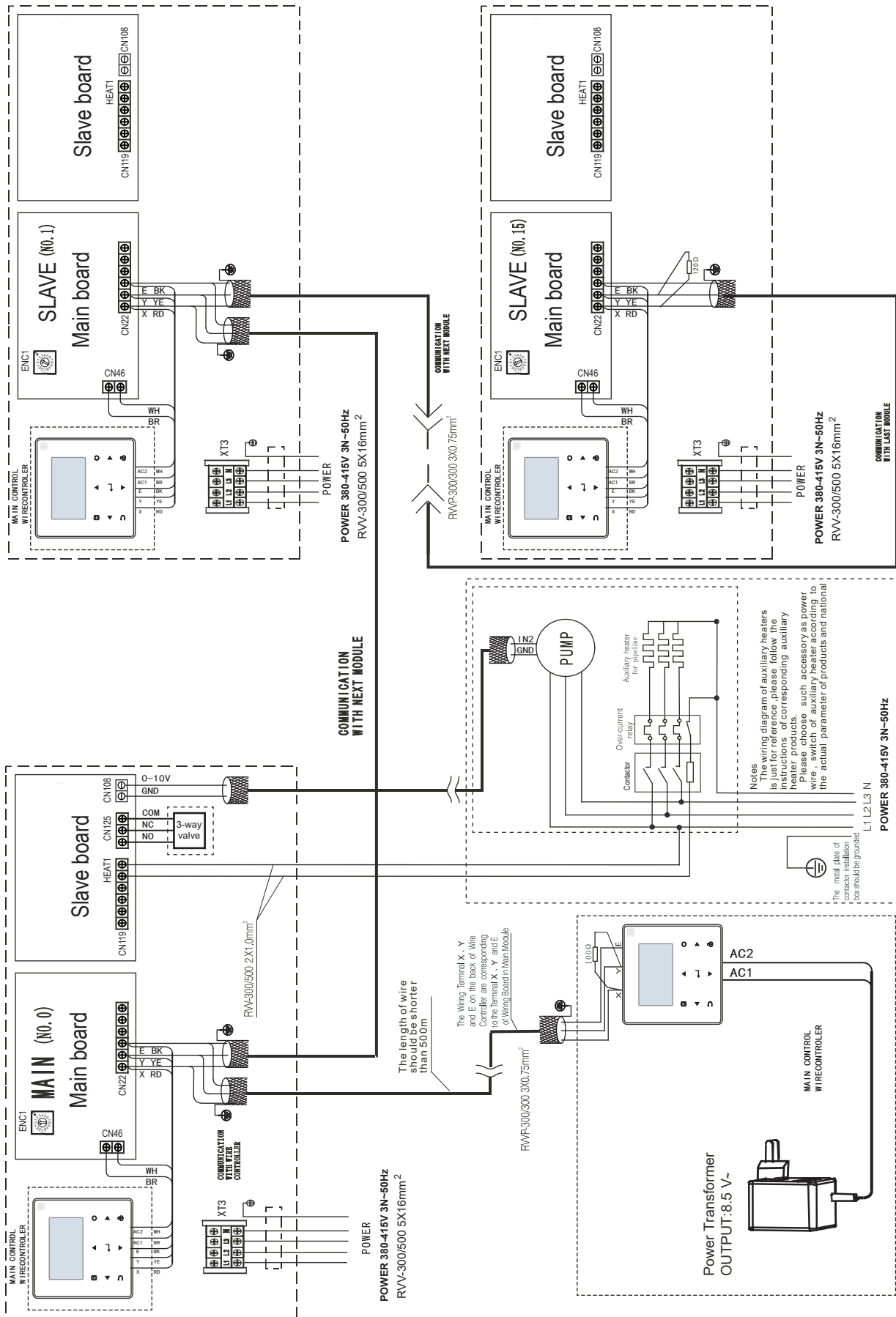

Fig. 8-17 Networking communication schematic of main unit and auxiliary unit for 65KW and 75KW

If multiple units are connected in cascade, the unit address should be set on the DIP switch ENC1. With 0-F being valid, 0 indicates the master unit and 1-F indicate slave units.

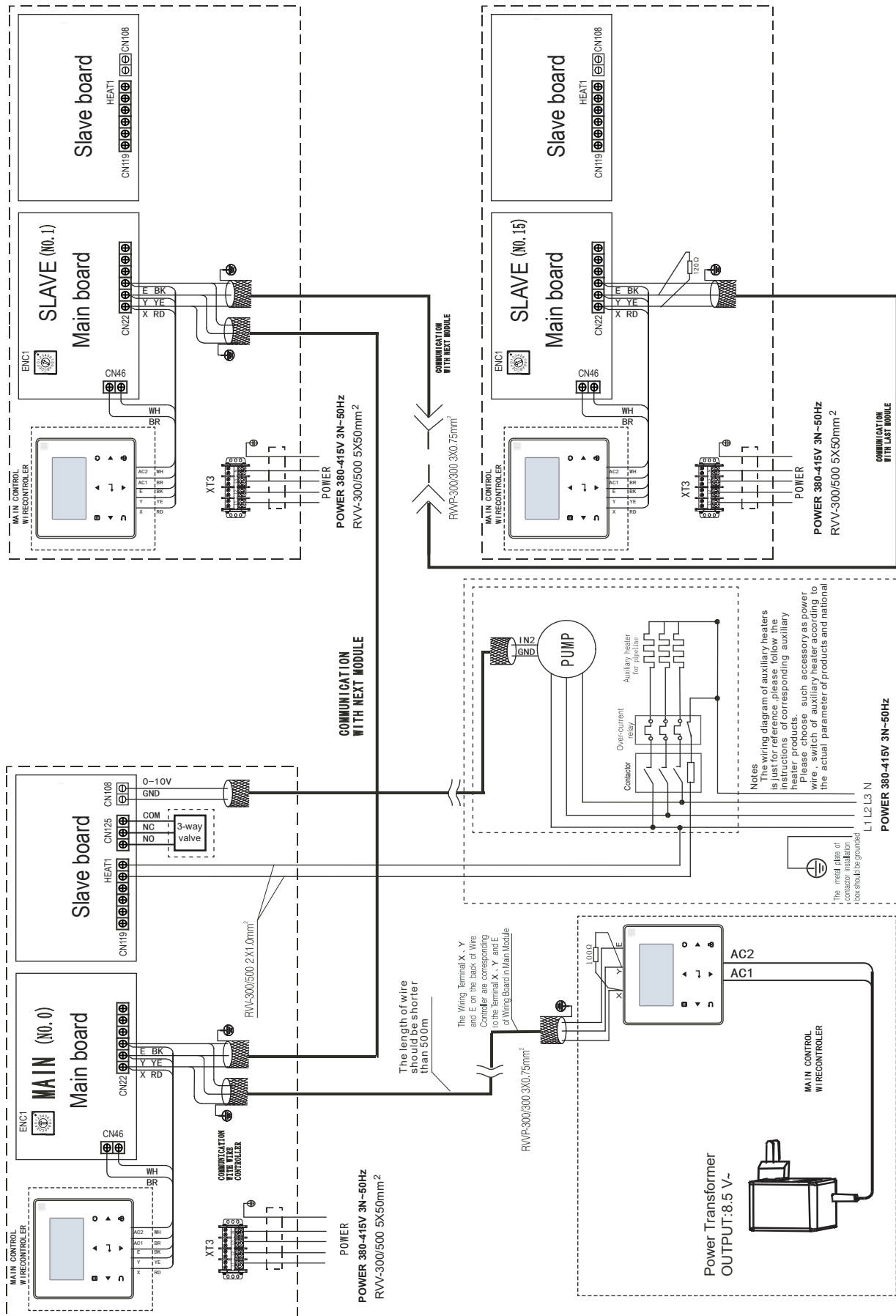

Fig. 8-18 Networking communication schematic of main unit and auxiliary unit for 110KW and 140KW

NOTE

When the power cord is parallel to the signal wire, make sure that they are enclosed in respective conduits and are kept a reasonable wire spacing. (Distance between the power cord and signal wire: 300mm if below 10A, and 500mm if below 50A)

CAUTION

In the case of multiple units connection, the HMI of 65KW,75KW,110KW and 140KW can be paralleled with in the same system.

8.5 Water system installation

8.5.1 Basic requirements of connection of chilled water pipes

CAUTION

- After the unit is in place, chilled water pipes can be laid.
- The relevant installation regulations should be abided with when conducting connection of water pipes.
- The pipelines should be free of any impurity, and all chilled water pipes must conform to local rules and regulations of pipeline engineering.

Connection requirements of chilled water pipes

- a) All chilled water pipelines should be thoroughly flushed, to be free of any impurity, before the unit is operated. Any impurity should not be flushed to or into the heat exchanger.
- b) Water must enter the heat exchanger through the inlet; otherwise the performance of the unit will decline.
- c) The pump installed in the water pipeline system should be equipped with starter. The pump will directly press water into the heat exchanger of the water system.
- e) The pipes and their ports must be independently supported but should not be supported on the unit.
- f) The pipes and their ports of the heat exchanger should be easy to disassemble for operation and cleaning, as well as inspection of port pipes of the evaporator.
- g) The evaporator should be provided with a filter with more than 40 meshes per inch at site. The filter should be installed near to the inlet port as much as possible, and be under heat preservation.
- h) The by-pass pipes and by-pass valves must be mounted for the heat exchanger, to facilitate cleaning of the outside system of water passage before the unit is adjusted. During maintenance, the water passage of the heat exchanger can be cut off without disturbing other heat exchangers.
- i) The flexible ports should be adopted between the interface of the heat exchanger and on-site pipeline, to reduce transfer of vibration to the building.

j) To facilitate maintenance, the inlet and outlet pipes should be provided with thermometer or manometer. The unit is not equipped with pressure and temperature instruments, so they need to be purchased by the user.

k) All low positions of the water system should be provided with drainage ports, to drain water in the evaporator and the system completely; and all high positions should be supplied with discharge valves, to facilitate expelling air from the pipeline. The discharge valves and drainage ports should not be under heat preservation, to facilitate maintenance.

l) All possible water pipes in the system to be chilled should be under heat preservation, including inlet pipes and flanges of the heat exchanger.

m) The outdoor chilled water pipelines should be wrapped with an auxiliary heating belt for heat preservation, and the material of the auxiliary heat belt should be PE, EDPM, etc., with thickness of 20mm, to prevent the pipelines from freezing and thus cracking under low temperature. The power supply of the heating belt should be equipped with an independent fuse.

n) The common outlet pipelines of combined units should be provided with mixing water temperature sensor.

WARNING

- For the water pipeline network including filters and heat exchangers, dreg or dirt may seriously damages the heat exchangers and water pipes.
- The installation persons or the users must ensure the quality of chilled water, and de-icing salt mixtures and air should be excluded from the water system, since they may oxidize and corrode steel parts inside the heat exchanger.
- When the ambient temperature is lower than 2℃, and the unit will be not used for a long time, water inside the unit should be drained. If the unit is not drained in winter, its power supply should not be cut off, and the fan coils in the water system must be provided with three-way valves, to ensure smooth circulation of the water system when the anti-freezing pump is started up in winter.

8.5.2 Connection mode of pipe

The water inlet and outlet pipes are installed and connected as shown in the following figures. 65KW,75KW,110KW and 140KW model uses hoop connection. For the specifications of the water pipes and screw thread, see the Table 8-6 below.

Table 8-6

Model	Pipe connection methods	Specifications of water pipe
65KW&75KW	Hoop connection	DN50
110KW&140KW	Hoop connection	DN65

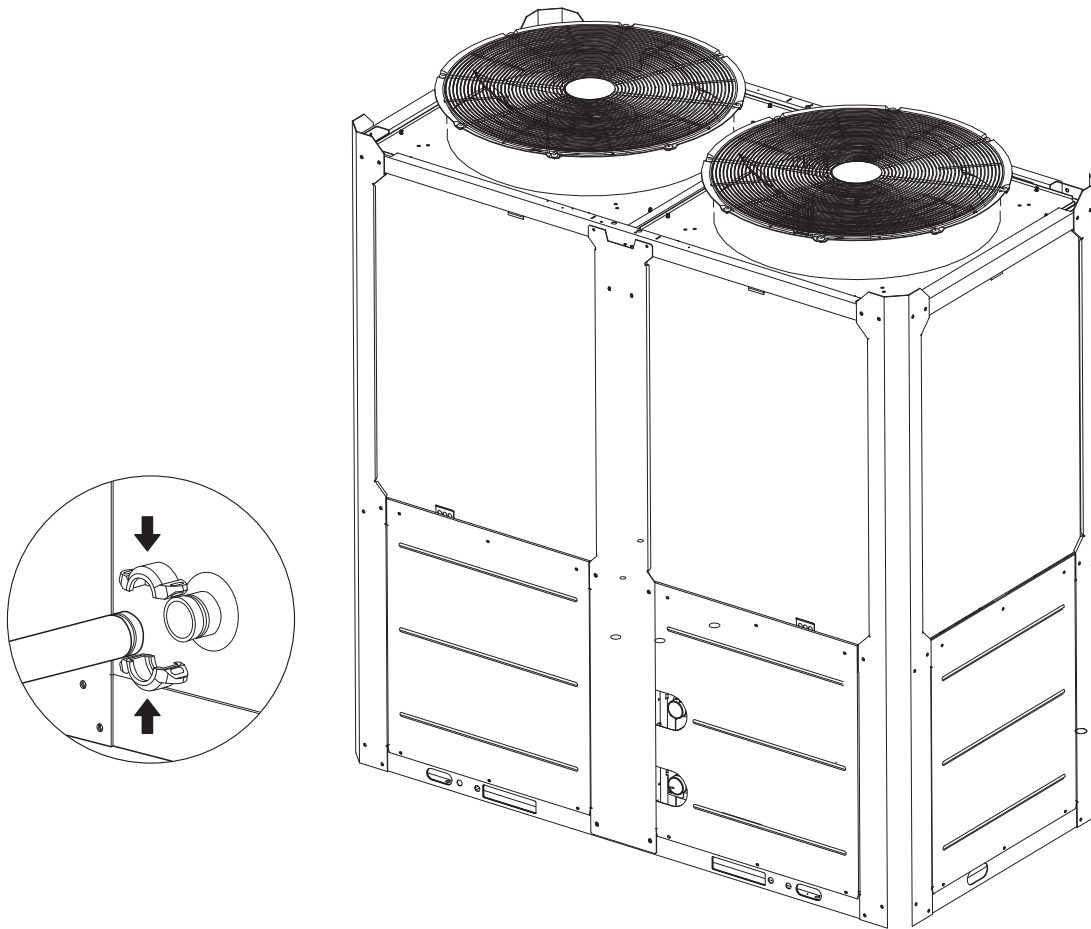

Fig.8-19

8.5.3 Design of the store tank in the system

kW is the unit for cooling capacity and L is the unit for G, water flow in the formula counting the minimum water flow.

Comfortable air conditioner
 $G = \text{cooling capacity} \times 3.5L$

Process cooling
 $G = \text{cooling capacity} \times 7.4L$

In certain occasion (especially in manufacture cooling process), for conforming the system water content requirement, it's necessary to mount a tank equipping with a cut-off baffle at the system to avoid water short-circuit, Please see the following schemes:

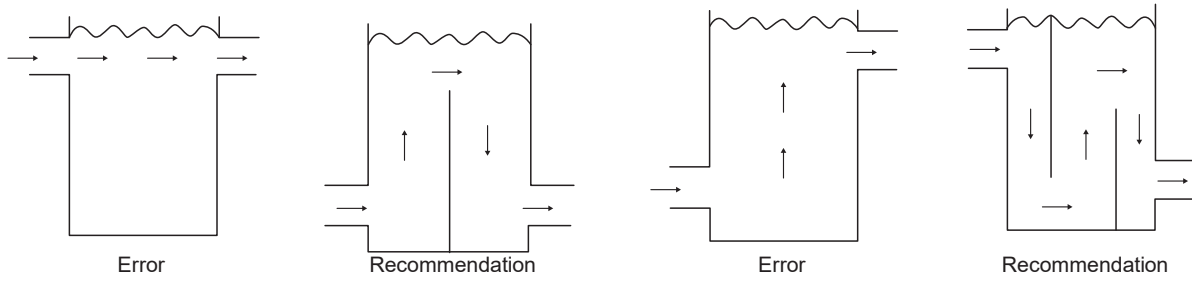

Fig.8-20 Design of the store tank

8.5.4 Minimum chilled water flow

The minimum chilled water flow is shown in the table 8-7
 If the system flow is less than the minimum unit flow rate, the evaporator flow can be recirculated, as shown in the diagram.

For minimum chilled water flow rate

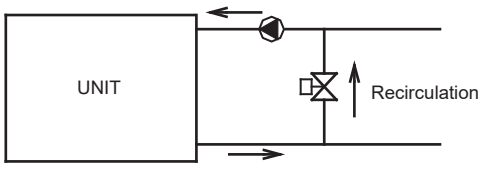

Fig. 8-21-1

8.5.5 Maximum chilled water flow

The maximum chilled water flow is limited by the permitted pressure drop in the evaporator. It is provided in the table 8-7

If the system flow is more than the maximum unit flow rate, bypass the evaporator as shown in the diagram to obtain a lower evaporator flow rate.

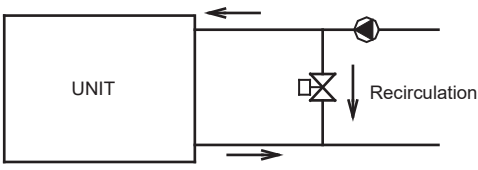

Fig. 8-21-2

8.5.6 Minimum and Maximum water flow

Table 8-7

Model	Item	Waterflow rate(m³/h)	
		Minimum	Maximum
65KW&75KW		3.0	14.0
110KW&140KW		5.0	26.0

8.5.7 Selection and installation of the pump

1) Select the pump
The unit must be equipped with variable frequency pump. Pump output is controlled through CN108(0-10V) in slave board.

a) Select the water-flow of the pump
 The rated water-flow must no less than the unit rated water-flow; in terms of multi-connect the units, that water-flow must no less than total units' rated water-flow. The unit must be equipped with variable frequency pump.

b) Select the lift of the pump.

$$H=h1+h2+h3+h4$$

H: The lift of the pump.

h1: Main unit water resistance.

h2: Pump water resistance.

h3: Water resistance of the longest water-loop distance, includes:

pipe resistance, different valve's resistance, flexible pipe resistance, pipe elbow and three-way resistance, two-way resistance or three-way resistance, as well as filter resistance.

H4: the longest terminal resistance.

2) Installation the pump

a) The pump should be installed at the water inlet pipe, both of which sides must mount the soft connectors for vibration-proof.

b) The backup pump for the system (recommended).

c) Units must with a main unit controls (Please see Fig. 8-18 for the controls wiring diagram).

8.5.8 Water quality

1) Water quality control

When industrial water is used as chilled water, little furring may occur; however, well water or river water, used as chilled water, may cause much sediment, such as furring, sand, and so on.

Therefore, well water or river water must be filtered and softened in softening water equipment before flowing into chilled water system. If sand and clay settle in the evaporator, circulation of chilled water may be blocked, and thus leading to freezing accidents; if hardness of chilled water is too high, furring may occur easily, and the devices may be corroded. Therefore, the quality of chilled water should be analyzed before being used, such as PH value, conductivity, concentration of chloride ion, concentration of sulfide ion, and so on.

2) Applicable standard of water quality for the unit

Table 8-8

PH value	6.8~8.0	Sulfate	<50ppm
Total hardness	<70ppm	Silicon	<30ppm
Conductivity	<200 μ V/cm(25°C)	Iron content	<0.3ppm
Sulfide ion	No	Sodium ion	No requirement
Chloride ion	<50ppm	Calcium ion	<50ppm
Ammonia ion	No	/	/

8.5.9 Installation of multi-module water system pipeline

Multi-module combination installation involves special design of the unit, so relevant explanation is given as follows.

1) Installation mode of multi-module combination water system pipeline

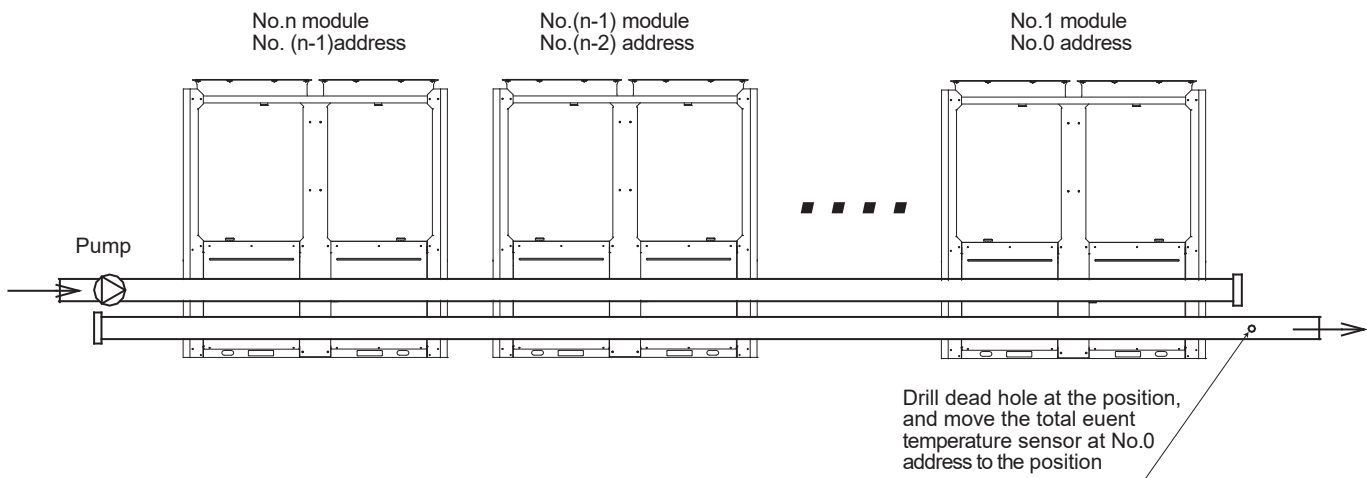

Fig.8-22 Installation of multi-module (no more than 16 modules)

2) Table of diameter parameters of main inlet and outlet pipes

Table 8-9

Cooling capacity	Total inlet and outlet water pipe inside nominal diameter
15 \leq Q \leq 30	DN40
30 < Q \leq 90	DN50
90 < Q \leq 140	DN65
140 < Q \leq 210	DN80
210 < Q \leq 325	DN100
325 < Q \leq 510	DN125
510 < Q \leq 740	DN150
740 < Q \leq 1300	DN200
1300 < Q \leq 2080	DN250

⚠ CAUTION

- Please pay attention to the following items when installing multiple modules:
 - Each module corresponds to an address code which cannot be repeated.
 - Main water outlet temperature sensing bulb, target flow controller and auxiliary electric heater are under control of the main module.
 - One wired controller and one target flow controller are required and connected on the main module.
 - The unit can be started up through the wired controller only after all addresses are set and the aforementioned items are determined. The wire length between the wired controller and outdoor unit should be <500m.

8.5.10 Installation of single or multiple water pumps

1) DIP switch

The choice of DIP switch see Table 8-4 in detail when single or multiple water pumps are installed for SCV-650B-3 and SCV-110B-3.

Pay attention to the following problems:

- a. If the DIP switch is inconsistent, and the error code is FP, the unit is not allowed to operate.
- b. Only the main unit has the water pump output signal when single water pump installed, auxiliary units has no water pump output signal.
- c. The water pump control signal is available for both the main unit and auxiliary units when multiple pumps installed.

2) Installation of water pipe system

Each unit is required to install a one-way valve, refer to figure as follow.

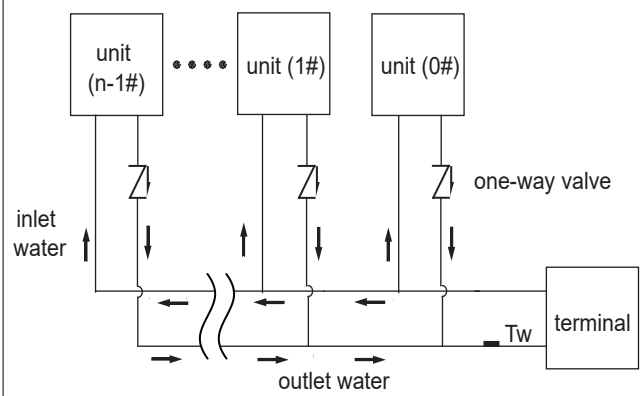

Fig.8-24 Installation of water pipe system

3) Electric wiring

Only the main unit requires wiring when single water pump installed, auxiliary units do not require wiring. All of the main unit and auxiliary units require wiring when multiple water pumps installed. For specific wiring, see figure 8-18.

9 STRAT-UP AND CONFIGURATION

9.1 Initial start-up at low outdoor ambient temperatures

During initial start-up and when water temperature is low, it is important that the water is heated gradually. Failure to do so may result in concrete floors cracking due to rapid temperature change. Please contact the responsible cast concrete building contractor for further details.

9.2 Points for attention prior to trial run

- 1) After the water system pipeline is flushed several times, please make sure that the purity of water meets the requirements; the system is re-filled with water and drained, and the pump is started up, then make sure that water flow and the pressure at the outlet meet the requirements.
- 2) The unit is connected to the main power 12 hours before being started up, to supply power to the heating belt and pre-heat the compressor. Inadequate pre-heating may cause damages to the compressor.
- 3) Setting of the wired controller. See details of the manual concerning setting contents of the controller, including such basic Zsettings as refrigerating and heating mode, manual adjustment and automatic adjustment mode and pump mode. Under normal circumstances, the parameters are set around standard operating conditions for trial run, and extreme working conditions should be prevented as much as possible.
- 4) Carefully adjust the target flow controller on the water system or the inlet stop valve of the unit, to make the water flow of the system be 90% of the water flow specified in troubleshooting table.

10 TEST RUN AND FINAL CHECK

10.1 Check item table after installation

Table 10-1

Checking item	Description	Yes	No
Whether installing site is meet for requirements	Units are fixed mounting on level base.		
	Ventilating space for heat exchanger at the air side is meeting for requirement		
	Maintenance space is meeting for requirement.		
	Noise and vibration is meeting for requirement.		
	Sun radiation and rain or snow proof measures are meeting for requirements.		
	External physical is meeting for requirement.		
Whether water system is meeting for requirements	Pipe diameter is meeting for requirement		
	The length of system is meeting for requirement		
	Water discharge is meeting for requirement		
	Water quality control is meeting for requirement		
	Flexible tube's interface is meeting for requirement		
	Pressure control is meeting for requirement		
	Thermal insulation is meeting for requirement		
	Wire capacity is meeting for requirement		
	Switch capacity is meeting for requirement		
	Fuse capacity is meeting for requirement		
	Voltage and frequency are meeting for requirement		
	Whether electric wiring system is meeting for requirements	Connecting tightly between wires	
Operation control device is meeting for requirement			
Safety device is meeting for requirement			
Chained control is meeting for requirement			
Phase sequence of power supply is meeting for requirement			

10.2 Trial run

- 1) Start up the controller and check whether the unit displays a fault code. If a fault occurs, remove the fault first, and start the unit according to the operating method in the "unit control instruction", after determining that there is no fault existing in the unit.
- 2) Conduct trial run for 30 min. When the influent and effluent temperature becomes stabilized, adjust the water flow to nominal value, to ensure normal operation of the unit.
- 3) After the unit is shut down, it should be put into operation 10 minutes later, to avoid frequent start-up of the unit. In the end, check whether the unit meets the requirements according to the contents in Table 11-1.

CAUTION

- The unit can control start-up and shut-down of the unit, so when the water system is flushed, the operation of the pump should not be controlled by the unit.
- Do not start up the unit before draining the water system completely.
- The target flow controller must be installed correctly. The wires of the target flow controller must be connected according to electric control schematic diagram, or the faults caused by water breaking while the unit is in operation should be the user's responsibility.
- Do not re-start the unit within 10 min after the unit is shut down during trial run.
- When the unit is used frequently, do not cut off the power supply after the unit is shut down; otherwise the compressor cannot be heated, thus leading to its damages.
- If the unit is not in service for a long time, and the power supply needs to be cut off, the unit should be connected to the power supply 12 hours prior to re-starting of the unit, to pre-heat the compressor, the pump, the plate heat exchanger and the differential pressure valve.

11 MAINTENANCE AND UPKEEP

11.1 Failure information and code

In case the unit runs under abnormal condition, failure protection code will display on both control panel and wired controller, and the indicator on the wired controller will flash with 1Hz. The display codes are shown in the following table:

Table11-1 65KW & 75KW & 110KW & 140KW

No.	Code	Content	Note
1	E0	Main control Model setting error (Other Model Main control EPROM error)	The capability selection is inconsistent with the actual model. Power on again after setting correctly
2	E1	Phase sequence error of main control board check	Recovered upon failure recovery
3	E2	Communication failure between master and the HMI or master and slave	Recovered upon failure recovery
		2E2:Communication failure between main board and slave board	Recovered upon failure recovery
4	E3	Total water outlet temperature sensor failure (main unit valid)	Recovered upon failure recovery
5	E4	Unit water outlet temperature sensor failure	Recovered upon failure recovery
6	E5	1E5 condenser tube temperature sensor T3A failure	Recovered upon failure recovery
		2E5 condenser tube temperature sensor T3B failure	Recovered upon failure recovery
7	E6	Water tank temperature sensor T5 failure	Recovered upon failure recovery
8	E7	Ambient temperature sensor failure	Recovered upon failure recovery
9	E8	Power supply phase sequence protector output error	Recovered upon failure recovery
10	E9	Water flow detection failure	Failure locking for 3 times in 60 minutes (Recovered by power off or Wired controller clear fault)
11	Eb	1Eb-->Taf1 the pipe of the tank antifreeze protection sensor failure	Recovered upon failure recovery
		2Eb-->Taf2 cooling evaporator low-temperature antifreeze protection sensor failure	Recovered upon failure recovery
12	EC	Slave unit module reduction	Recovered upon failure recovery
13	Ed	system discharge temperature sensor failure	Recovered upon failure recovery
14	EE	1EE EVI plate heat exchanger refrigerant temperature T6A sensor failure	Recovered upon failure recovery
		2EE EVI plate heat exchanger refrigerant temperature T6B sensor failure	Recovered upon failure recovery
15	EF	Unit water return temperature sensor failure	Recovered upon failure recovery
16	EP	Discharge sensor failure alarm	Recovered upon failure recovery
17	EU	Tz sensor failure	Recovered upon failure recovery
18	P0	P0 System high-pressure protection or discharge temperature protection	for 3 times in 60 minutes (Recovered by power off)
		1P0 Compressor module 1 high pressure protection	Recovered upon failure recovery
		2P0 Compressor module 2 high pressure protection	Recovered upon failure recovery
19	P1	System low pressure protection (or Severe refrigerant leakage protection)	for 3 times in 60 minutes (Recovered by power off)
20	P3	T4 ambient temperature too high in cooling mode	Recovered upon failure recovery
21	P4	1P4 System A current protection	for 3 times in 60 minutes (Recovered by power off)
		2P4 System ADC bus current protection	
22	P5	1P5 System B current protection	for 3 times in 60 minutes (Recovered by power off)
		2P5 System B DC bus current protection	
23	P6	Inverter module failure	Recovered upon error recovery
24	P7	High temperature protection of system condenser	for 3 times in 60 minutes (Recovered by power off)
25	P9	Water inlet and outlet temperature difference protection	Recovered upon failure recovery
26	PA	Abnormal water inlet and outlet temperature difference protection	Recovered upon failure recovery
27	Pb	Winter antifreeze protection	Reminder code, non fault or protection
28	PC	Cooling evaporator pressure too low	Recovered upon error recovery
			for 3 times in 60 minutes (Recovered by power off)
29	PE	Cooling evaporator low temperature antifreeze protection	Recovered upon error recovery
			for 3 times in 60 minutes (Recovered by power off)
30	PH	Heating T4 too high temperature protection	Recovered upon error recovery
31	PL	Tfin module temperature too high protection	for 3 times in 100 minutes (Recovered by power off)
32	PU	1PU DC fan A module protection	Recovered upon failure recovery
		2PU DC fan B module protection	Recovered upon failure recovery
33	bH	1bH:Module 1 relay blocking or 908 chip self-check failed	Recovered upon error recovery
		2bH:Module 2 relay blocking or 908 chip self-check failed	Recovered upon error recovery
34	H5	Voltage too high or too low	Recovered upon error recovery
35	xH9	1H9 Compressor A inverter module is not matched	Recovered upon error recovery
		2H9 Compressor B inverter module is not matched	Recovered upon error recovery
36	HC	High pressure sensor failure	Recovered upon error recovery
37	HE	1HE No inset A valve error	Recovered upon error recovery
		2HE No inset B valve error	Recovered upon error recovery
		3HE No inset C valve error	Recovered upon error recovery
38	F0	1F0 IPM module A transmission error	Recovered upon error recovery
		2F0 IPM module B transmission error	Recovered upon error recovery
39	F2	Superheat insufficient	Wait at least 20min before recovering

No.	Code	Content	Note
40	F4	1F4 module A L0 or L1 protection occurs for 3 times in 60 minutes	Recovered by power off
		2F4 module B L0 or L1 protection occurs for 3 times in 60 minutes	Recovered by power off
41	F6	1F6 A system bus voltage error (PTC)	Recovered upon error recovery
		2F6 B system bus voltage error (PTC)	Recovered upon error recovery
42	Fb	Low pressure sensor error	Recovered upon error recovery
43	Fd	Suction temperature sensor error	Recovered upon error recovery
44	FF	1FF DC fan A error	Recovered by power off
		2FF DC fan B error	Recovered by power off
45	FP	DIP switch inconsistency of multiple water pumps	Recovered by power off
46	C7	If PL occurs 3 times in 100 minutes, the system reports the C7 failure	Recovered by power off or Wired controller clear fault
47	xL0	Compressor inverter module protection(x=1or 2,1 for Compressor A,2 for Compressor B)	Recovered upon error recovery
48	xL1	low-voltage protection(x=1or 2,1 for Compressor A,2 for Compressor B)	Recovered upon error recovery
49	xL2	high-voltage protection(x=1or 2,1 for Compressor A,2 for Compressor B)	Recovered upon error recovery
50	xL4	MCE error(x=1or 2,1 for Compressor A,2 for Compressor B)	Recovered upon error recovery
51	xL5	zero-speed protection(x=1or 2,1 for Compressor A,2 for Compressor B)	Recovered upon error recovery
52	xL7	phase loss(x=1or 2,1 for Compressor A,2 for Compressor B)	Recovered upon error recovery
53	xL8	frequency change over 15Hz(x=1or 2,1 for Compressor A,2 for Compressor B)	Recovered upon error recovery
54	xL9	frequency phase difference 15Hz(x=1or 2,1 for Compressor A,2 for Compressor B)	Recovered upon error recovery
55	dF	Defrosting prompt	Flash when entering the defrosting
56	L10	Overcurrent protection	Overcurrent fault
	L11	Transient phase current overcurrent protection	
	L12	Phase current overcurrent lasts 30s protection	
57	L20	Module over temperature protection	Over temperature fault
58	L30	Low bus voltage error	Power fault
	L31	High bus voltage error	
	L32	Excessively high bus voltage error	
	L34	Phase loss error	
59	L43	Phase current sampling bias abnormal	hardware fault
	L45	Motor code not match	
	L46	IPM protection	
	L47	Module type not match	
60	L50	Startup failure	Control fault
	L51	Out of step error	
	L52	Zero speed error	
61	L60	Fan motor phase loss protection	Diagnostic fault
	L65	IPM short circuit error	
	L66	FCT detection error	
	L6A	Open circuit of U-phase upper tube	
	L6B	Open circuit of U-phase lower tube	
	L6C	Open circuit of V-phase upper tube	
	L6D	Open circuit of V-phase lower tube	
	L6E	Open circuit of W-phase upper tube	
L6F	Open circuit of W-phase lower tube		

11.2 Digital display of main board

The data display area is divided into Up area and Down area, with two groups of two-digit half 7-segment digital display, respectively.

a. Temperature display

Temperature display is used for displaying the total outlet water temperature of unit system, outlet water temperature, condenser pipe temperature T3A of system A, condenser pipe temperature T3B of system B, outdoor environmental temperature T4, anti-freezing temperature T6 and setting temperature Ts, with allowable data display scope $-15^{\circ}\text{C}\sim 70^{\circ}\text{C}$. If the temperature is higher than 70°C , it is displayed as 70°C . If there is no effective date, it displays "—" and indication point °C is on.

b. Current display

Current display is used for displaying Modular unit system A compressor current IA or system B compressor current IB, with allowable display scope 0A~99A. If it is higher than 99A, it is displayed as 99A. If there is no effective date, it displays "—" and indication point A is on.

c. Failure display

It is used for displaying the total failure warning date of unit or that of Modular unit, with failure display scope E0~EF, E indicating failure, 0~F indicating failure code. "E-" is displayed when there is no failure and indication point # is on at the same time.

d. Protection display

It is used for displaying the total system protection data of unit or the system protection data of Modular unit, with protection display scope P0~PF, P indicating system protection, 0~F indicating protection code. "P-" is displayed when there is no failure.

e. Unit number display

It is used for displaying the address number of the currently selected Modular unit, with display scope 0~15 and indication point # is on at the same time.

f. Display of online unit number and startup unit number

They are used for displaying the total online Modular units of the whole unit system and the number of the Modular unit under running state, respectively, with display scope 0~16. Any time when the spot check page is entered to display or change Modular unit, it is needed to wait for the up-to-date data of the Modular unit received and selected by wired controller. Before receiving the data, the wired controller only displays "—" on the data display Down area, and the Up area displays the address number of the Modular unit. No page can be turned, which continues until the wired controller receives the communication data of this Modular unit.

11.3 Care and maintenance

1) Maintenance period

It's recommended that before cooling in summer and heating in winter every year, consult local air conditioner customer service center to check and maintain the unit, to prevent air conditioner errors which bring inconvenience to your life and work.

2) Maintenance of main parts

Close attention should be paid to the discharge and suction pressure during the running process. Find out reasons and eliminate the failure if abnormality is found.

Control and protect the equipment. See to it that no random adjustment be made on the set points on site.

Regularly check whether the electric connection is loose, and whether there is bad contact at the contact point caused by oxidation and debris etc., and take timely measures if necessary.

Frequently check the work voltage, current and phase balance.

Check the reliability of the electric elements in time. Ineffective and unreliable elements should be replaced in time.

11.4 Removing scale

After long-time operation, calcium oxide or other minerals will be settled in the heat transfer surface of the water-side heat exchanger. These substances will affect the heat transfer performance when there is too much scale in the heat transfer surface.

and sequentially cause that electricity consumption increases and the discharge pressure is too high (or suction pressure too low). Organic acids such as formic acid, citric acid and acetic acid may be used to clean the scale. But in no way should cleaning agent containing fluoroacetic acid or fluoride should be used as the water-side heat exchange is made from stainless steel and is easy to be eroded to cause refrigerant leakage. Pay attention to the following aspects during the cleaning and scale-removing process:

1) Water-side heat exchanger should be done by professionals. Please contact the local air-conditioner customer service center.

2) Clean the pipe and heat exchanger with clean water after cleaning agent is used. Conduct water treatment to prevent water system from being eroded or re-absorption of scale.

3) In case of using cleaning agent, adjust the density of the agent, cleaning time and temperature according to the scale settlement condition.

4) After pickling is completed, neutralization treatment needs to be done on the waste liquid. Contact relevant company for treating the treated waste liquid.

5) Protection equipments (such as goggles, gloves, mask and shoes) must be used during the cleaning process to avoid breathing in or contacting the agent as the cleaning agent and neutralization agent is corrosive to eyes, skins and nasal mucosa.

11.5 Winter shutdown

For shutdown in winter, the surface of the unit outside and inside should be cleaned and dried. Cover the unit to prevent dust. Open discharge water valve to discharge the stored water in the clean water system to prevent freezing accident (it is preferable to inject antifreezer in the pipe).

11.6 Replacing parts

Parts to be replaced should be the ones provided by our company.

Never replace any part with different part.

11.7 First startup after shutdown

The following preparations should be made for re-startup of unit after long-time shutdown:

- 1) Thoroughly check and clean unit.
- 2) Clean water pipe system.
- 3) Check pump, control valve and other equipments of water pipe system.
- 4) Fix connections of all wires.
- 5) It is a must to electrify the machine 12 hours before startup.

11.8 Refrigeration system

Determine whether refrigerant is needed by checking the value of suction and discharge pressure and check whether there is a leakage. Air tight test must be made if there is a leakage or parts of refrigerating system is to be replaced. Take different measures in the following two different conditions from refrigerant injection.

- 1) Total leakage of refrigerant. In case of such situation, leakage detection must be made on the pressurized nitrogen used for the system. If repair welding is needed, welding cannot be made until all the gas in the system is discharged. Before injecting refrigerant, the whole refrigeration system must be completely dry and of vacuum pumping.

Connect vacuum pumping pipe at the fluoride nozzle at low-pressure side.

Remove air from the system pipe with vacuum pump. The vacuum pumping lasts for above 3 hours. Confirm that the indication pressure in dial gauge is within the specified scope.

When the degree of vacuum is reached, inject refrigerant into the refrigeration system with refrigerant bottle. Appropriate amount of refrigerant for injection has been indicated on the nameplate and the table of main technical parameters. Refrigerant must be injected from the low pressure side of system.

The injection amount of refrigerant will be affected by the ambient temperature. If the required amount has not been reached but no more injection can be done, make the chilled water circulate and start up the unit for injection. Make the low pressure switch temporarily short circuit if necessary.

- 2) Refrigerant supplement. Connect refrigerant injection bottle on the fluoride nozzle at low-pressure side and connect pressure gauge at low pressure side.

Make chilled water circulate and start up unit, and make the low pressure control switch short circuit if necessary.

Slowly inject refrigerant into the system and check suction and discharge pressure.

CAUTION

- Connection must be renewed after injection is completed.
- Never inject oxygen, acetylene or other flammable or poisonous gas to the refrigeration system at leakage detection and air tight test. Only pressurized nitrogen or refrigerant can be used.

11.9 Disassembling compressor

Follow the following procedures if compressor needs to be disassembled:

- 1) Cut off the power supply of unit.
- 2) Remove power source connection wire of compressor.
- 3) Remove suction and discharge pipes of compressor.
- 4) Remove fastening screw of compressor.
- 5) Move the compressor.

11.10 Auxiliary electric heater

When the ambient temperature is lower than 2°C, the heating efficiency decreases with the decline of the outdoor temperature. In order to make the air-cooled heat pump stably run in a relatively cold region and supplement some heat lost due to de-frosting. When the lowest ambient temperature in the user's region in winter is within 0°C~10°C, the user may consider to use auxiliary electric heater.

Please refer to relevant professionals for the power of auxiliary electric heater.

11.11 System antifreezing

In case of freezing at the water-side heat exchanger interval channel, severe damage may be caused, i.e. heat exchange may be broken and appears leakage. This damage of frost crack is not within the warranty scope, so attention must be paid to antifreezing.

- 1) If the unit that is shutdown for standby is placed in an environment where the outdoor temperature is lower than 0°C, the water in the water system should be drained.
- 2) Water pipe may be frozen when the chilled water target flow controller and anti-freezing temperature sensor become ineffective at running, therefore, the target flow controller must be connected in accordance with the connection diagram.
- 3) Frost crack may happen to water-side heat exchanger at maintenance when refrigerant is injected to the unit or is discharged for repair. Pipe freezing is likely to happen any time when the pressure of refrigerant is below 0.4Mpa. Therefore, the water in the heat exchanger must be kept flowing or be thoroughly discharged.

11.12 Replacement of safety valve

Replace the safety valve as follows:

- 1) Reclaim the refrigerant completely in the system. Doing so requires professional staff and equipment;
- 2) Note to protect the tank coating. Please avoid damaging to coating from external force or high temperature when removing and installing the safety valve;
- 3) Heat the sealant to screw off the safety valve. Note to protect the area where the screwing tool meets the tank body and avoid damaging to the tank coating;
- 4) If tank coating is damaged, repaint the damaged area.

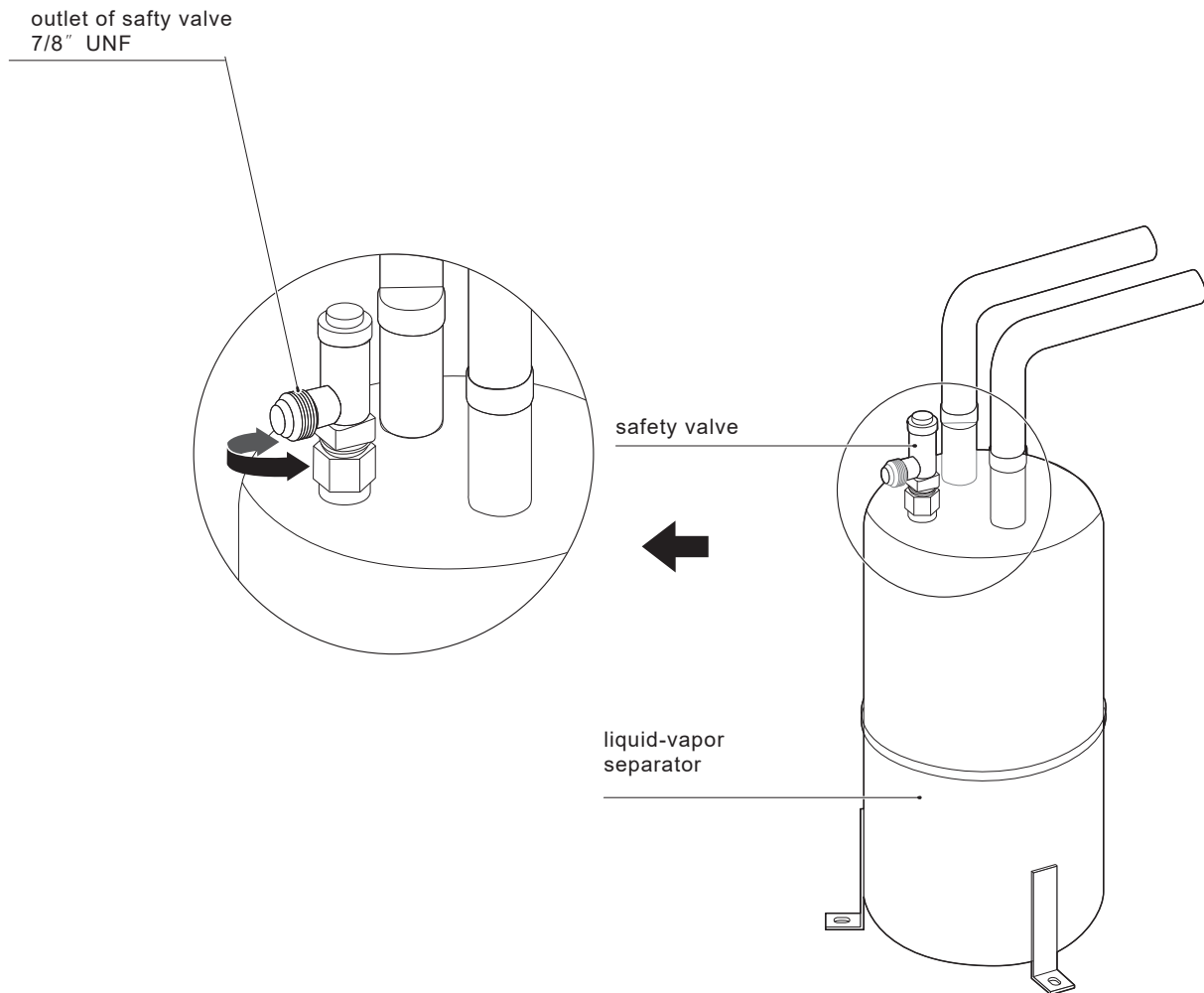

Fig.11-1 Replacement of safety valve

⚠ WARNING

- The air outlet of safty valve must be connected to the appropriate pipe,which can direct the leaking refrigerant to the appropriate place for discharge.
- Safety valve warranty period is 24 months. Under the specified conditions, if flexible sealing parts is used, the safety valve life expectancy is 24 to 36 months, If metal or PIFE sealing components is used, the average life expectancy is 36 to 48 months. Visual inspection is needed after that period, Serviceman should check the appearance of the valve body and the operating environment. If the valve body is not obvious corrosion, cracks, dirt, damage, then the valve can be used continually.Otherwise, please contact your supplier for spare part.

11.13 INFORMATION SERVICING

1) Checks to the area

Before working on systems containing flammable refrigerants, safety checks are necessary to ensure that the risk of ignition is minimised. For repair to the refrigerating system, the following precautions shall be complied with prior to conducting work on the system.

2) Work procedure

Works shall be undertaken under a controlled procedure so as to minimise the risk of a flammable gas or vapour being present while the work is being performed.

3) General work area

All maintenance staff and others working in the local area shall be instructed on the nature of work being carried out. Work in confined spaces shall be avoided. The area around the work space shall be sectioned off. Ensure that the conditions within the area have been made safe by controlling of flammable material.

4) Checking for presence of refrigerant

The area shall be checked with an appropriate refrigerant detector prior to and during work to ensure the technician is aware of potentially flammable atmospheres. Ensure that the leak detection equipment being used is suitable for use with flammable refrigerants, i.e. no sparking, adequately sealed or intrinsically safe.

5) Presence of fire extinguisher

If any hot work is to be conducted on the refrigeration equipment or any associated parts, appropriate fire extinguishing equipment shall be available to hand. Have a dry power or CO₂ fire extinguisher adjacent to the charging area.

6) No ignition sources

No person carrying out work in relation to a refrigeration system which involves exposing any pipe work that contains or has contained flammable refrigerant shall use any sources of ignition in such a manner that it may lead to the risk of fire or explosion. All possible ignition sources, including cigarette smoking, should be kept sufficiently far away from the site of installation. Repairing, removing and disposal, during which flammable refrigerant can possibly be released to the surrounding space. Prior to work taking place, the area around the equipment is to be surveyed to make sure that there are no flammable hazards or ignition risks. NO SMOKING signs shall be displayed.

7) Ventilated area

Ensure that the area is in the open or that it is adequately ventilated before breaking into the system or conducting any hot work. A degree of ventilation shall continue during the period that the work is carried out. The ventilation should safely disperse any released refrigerant and preferably expel it externally into the atmosphere.

8) Checks to the refrigeration equipment

Where electrical components are being changed, they shall be fit for the purpose and to the correct specification. At all times the manufacturer's maintenance and service guidelines shall be followed. If in doubt, please consult the manufacturer's technical department for assistance. The following checks shall be applied to installations using flammable refrigerants:

- The charge size is in accordance with the room size within which the refrigerant containing parts are installed;
- The ventilation machinery and outlets are operating adequately and are not obstructed;
- If an indirect refrigerating circuit is being used, the secondary circuits shall be checked for the presence of refrigerant; marking to the equipment continues to be visible and legible.
- Marking and signs that are illegible shall be corrected;
- Refrigeration pipe or components are installed in a position where they are unlikely to be exposed to any substance which may corrode refrigerant containing components, unless the components are constructed of materials which are inherently resistant to being corroded or are suitably protected against being so corroded.

9) Checks to electrical devices

Repair and maintenance to electrical components shall include initial safety checks and component inspection procedures. If a fault exists that could compromise safety, then no electrical supply shall be connected to the circuit until it is satisfactorily dealt with. If the fault cannot be corrected immediately but it is necessary to continue operation, an adequate temporary solution shall be used. This shall be reported to the owner of the equipment so all parties are advised.

Initial safety checks shall include:

- That capacitors are discharged: this shall be done in a safe manner to avoid possibility of sparking;
- That there are no live electrical components and wiring are exposed while charging, recovering or purging the system;
- That there is continuity of earth bonding.

10) Repairs to sealed components

a) During repairs to sealed components, all electrical supplies shall be disconnected from the equipment being worked upon prior to any removal of sealed covers, etc. If it is absolutely necessary to have an electrical supply to equipment during servicing, then a permanently operating form of leak detection shall be located at the most critical point to warn of a potentially hazardous situation.

b) Particular attention shall be paid to the following to ensure that by working on electrical components, the casing is not altered in such a way that the level of protection is affected. This shall include damage to cables, excessive number of connections, terminals not made to original specification, damage to seals, incorrect fitting of glands, etc.

- Ensure that apparatus is mounted securely.
- Ensure that seals or sealing materials have not degraded such that they no longer serve the purpose of preventing the ingress of flammable atmospheres. Replacement parts shall be in accordance with the manufacturer's specifications.

NOTE

The use of silicon sealant may inhibit the effectiveness of some types of leak detection equipment. Intrinsically safe components do not have to be isolated prior to working on them.

11) Repair to intrinsically safe components

Do not apply any permanent inductive or capacitance loads to the circuit without ensuring that this will not exceed the permissible voltage and current permitted for the equipment in use. Intrinsically safe components are the only types that can be worked on while live in the presence of a flammable atmosphere. The test apparatus shall be at the correct rating. Replace components only with parts specified by the manufacturer. Other parts may result in the ignition of refrigerant in the atmosphere from a leak.

12) Cabling

Check that cabling will not be subject to wear, corrosion, excessive pressure, vibration, sharp edges or any other adverse environmental effects. The check shall also take into account the effects of aging or continual vibration from sources such as compressors or fans.

13) Detection of flammable refrigerants

Under no circumstances shall potential sources of ignition be used in the searching for or detection of refrigerant leaks.

14) Leak detection methods

The following leak detection methods are deemed acceptable for systems containing flammable refrigerants. Electronic leak detectors shall be used to detect flammable refrigerants, but the sensitivity may not be adequate, or may need re-calibration. (Detection equipment shall be calibrated in a refrigerant-free area.) Ensure that the detector is not a potential source of ignition and is suitable for the refrigerant. Leak detection equipment shall be set at a percentage of the LFL of the refrigerant and shall be calibrated to the refrigerant employed and the appropriate percentage of gas (25% maximum) is confirmed. Leak detection fluids are suitable for use with most refrigerants but the use of detergents containing chlorine shall be avoided as the chlorine may react with the refrigerant and corrode the copper pipe-work. If a leak is suspected, all naked flames shall be removed or extinguished. If a leakage of refrigerant is found which requires brazing, all of the refrigerant shall be recovered from the system, or isolated (by means of shut off valves) in a part of the system remote from the leak. Oxygen free nitrogen (OFN) shall then be purged through the system both before and during the brazing process.

15) Removal and evacuation

When breaking into the refrigerant circuit to make repairs or for any other purpose, conventional procedures shall be used. However, it is important that best practice is followed since flammability is a consideration. The following procedure shall be as below:

- Remove refrigerant;
- Purge the circuit with inert gas;
- Evacuate;
- Purge again with inert gas;
- Open the circuit by cutting or brazing.

The refrigerant charge shall be recovered into the correct recovery cylinders. The system shall be flushed with OFN to render the unit safe. This process may need to be repeated several times.

Compressed air or oxygen shall not be used for this task.

Flushing shall be achieved by breaking the vacuum in the system with OFN and continuing to fill until the working pressure is achieved, then venting to atmosphere, and finally pulling down to a vacuum. This process shall be repeated until no refrigerant is within the system.

When the final OFN charge is used, the system shall be vented down to atmospheric pressure to enable work to take place. This operation is absolutely vital if brazing operations on the pipe-work are to take place.

Ensure that the outlet for the vacuum pump is not closed to any ignition sources and there is ventilation available.

16) Charging procedures

In addition to conventional charging procedures, the following requirements shall be followed:

- Ensure that contamination of different refrigerants does not occur when using charging equipment. Hoses or lines shall be as short as possible to minimize the amount of refrigerant contained in them.
- Cylinders shall be kept upright.
- Ensure that the refrigeration system is earthed prior to charging the system with refrigerant.

- Label the system when charging is complete(if not already).
- Extreme care shall be taken not to overfill the refrigeration system.
- Before recharging the system it shall be pressure tested with OFN. The system shall be leak tested on completion of charging but prior to commissioning. A follow up leak test shall be carried out prior to leaving the site.

17) Decommissioning

Before carrying out this procedure, it is essential that the technician is completely familiar with the equipment and all its detail. It is recommended good practice that all refrigerants are recovered safely. Before the task being carried out, an oil and refrigerant sample shall be taken.

In case analysis is required prior to re-use of reclaimed refrigerant. It is essential that electrical power is available before the task is commenced.

- Become familiar with the equipment and its operation.
- Isolate system electrically
- Before attempting the procedure ensure that:

- Mechanical handling equipment is available, if required, for handling refrigerant cylinders;
- All personal protective equipment is available and being used correctly;
- The recovery process is supervised at all times by a competent person;
- Recovery equipment and cylinders conform to the appropriate standards.

d) Pump down refrigerant system, if possible.

e) If a vacuum is not possible, make a manifold so that refrigerant can be removed from various parts of the system.

f) Make sure that cylinder is situated on the scales before recovery takes place.

g) Start the recovery machine and operate in accordance with manufacturer's instructions.

h) Do not overfill cylinders. (No more than 80% volume liquid charge).

i) Do not exceed the maximum working pressure of the cylinder, even temporarily.

j) When the cylinders have been filled correctly and the process completed, make sure that the cylinders and the equipment are removed from site promptly and all isolation valves on the equipment are closed off.

k) Recovered refrigerant shall not be charged into another refrigeration system unless it has been cleaned and checked.

18) Labelling

Equipment shall be labelled stating that it has been de-commissioned and emptied of refrigerant. The label shall be dated and signed. Ensure that there are labels on the equipment stating the equipment contains flammable refrigerant.

19) Recovery

When removing refrigerant from a system, either for service or decommissioning, it is recommended good practice that all refrigerants are removed safely.

When transferring refrigerant into cylinders, ensure that only appropriate refrigerant recovery cylinders are employed. Ensure that the correct numbers of cylinders for holding the total system charge are available. All cylinders to be used are designated for the recovered refrigerant and labelled for that refrigerant(i.e special cylinders for the recovery of refrigerant). Cylinders shall be complete with pressure relief valve and associated shut-off valves in good working order.

Empty recovery cylinders are evacuated and, if possible, cooled before recovery occurs.

The recovery equipment shall be in good working order with a set of instructions concerning the equipment that is at hand and shall be suitable for the recovery of flammable refrigerants. In addition, a set of calibrated weighing scales shall be available and in good working order.

Hoses shall be complete with leak-free disconnect couplings and in good condition. Before using the recovery machine, check that it is in satisfactory working order, has been properly maintained and that any associated electrical components are sealed to prevent ignition in the event of a refrigerant release. Consult manufacturer if in doubt.

The recovered refrigerant shall be returned to the refrigerant supplier in the correct recovery cylinder, and the relevant Waste Transfer Note arranged. Do not mix refrigerants in recovery units and especially not in cylinders.

If compressors or compressor oils are to be removed, ensure that they have been evacuated to an acceptable level to make certain that flammable refrigerant does not remain within the lubricant. The evacuation process shall be carried out prior to returning the compressor to the suppliers. Only electric heating to the compressor body shall be employed to accelerate this process. When oil is drained from a system, it shall be carried out safely.

20) Transportation, marking and storage for units

Transport of equipment containing flammable refrigerants compliance with the transport regulations

Marking of equipment using signs compliance with local regulations

Disposal of equipment using flammable refrigerants compliance with national regulations

Storage of equipment/appliances

The storage of equipment should be in accordance with the manufacturer's instructions.

Storage of packed (unsold) equipment

Storage package protection should be constructed such that mechanical damage to the equipment inside the package will not cause a leak of the refrigerant charge.

The maximum number of pieces of equipment permitted to be stored together will be determined by local regulations.

RECORD TABLE OF TEST RUN AND MAINTENANCE

Table 11-2

Model:	Code labeled on the unit:
Customer name and address:	Date:
<p>1. Check temperature of chilled water or hot water</p> <p style="padding-left: 40px;">Inlet () Outlet ()</p> <p>2. Check air temperature of air-side heat exchanger:</p> <p style="padding-left: 40px;">Inlet () Outlet ()</p> <p>3. Check refrigerant suction temperature and superheating temperature:</p> <p style="padding-left: 40px;">Refrigerant suction temperature: ()()()()()</p> <p style="padding-left: 40px;">Superheating temperature: ()()()()()</p> <p>4. Check pressure:</p> <p style="padding-left: 40px;">Discharge pressure: ()()()()()</p> <p style="padding-left: 40px;">Suction pressure: ()()()()()</p> <p>5. Check running current: ()()()()()</p> <p>6. Whether unit has been through refrigerant leakage test? ()</p> <p>7. Whether there is noise on all the panels of unit? ()</p> <p>8. Check whether the main power source connection is correct. ()</p>	

RECORD TABLE OF ROUTINE RUNNING

Table 11-3

Model:		Date:									
Weather:		Operation time: Startup () Shutdown ()									
Outdoor temperature	Dry bulb	°C									
	Wet bulb	°C									
Indoor temperature		°C									
Compressor	High pressure	MPa									
	Low pressure	MPa									
	Voltage	V									
	Current	A									
Air temperature of air-side heat exchanger	Inlet (dry bulb)	°C									
	Outlet (dry bulb)	°C									
Temperature of chilled water or hot water	Inlet	°C									
	Outlet	°C									
Current of cooling water pump or hot water pump		A									
Note:											

12 APPLICABLE MODELS AND MAIN PARAMETERS

Table 12-1

Model		65KW	75KW	110KW	140KW
Cooling capacity	kW	56.7	69.3	99.3	129.3
Heating capacity	kW	65.7	75.7	110.7	140.9
Standard cooling input	kW	19.8	28.3	34.1	52.0
Cooling rated current	A	30.5	43.6	52.6	80.2
Standard heating input	kW	19.4	23.5	31.2	47.1
Heating rated current	A	29.9	36.3	48.1	72.6
Power supply	380-415V 3N~ 50Hz				
Operation control	Control of wired controller, auto startup, running state display, failure alert etc.				
Safety device	High or low pressure switch, freeze-proof device, water flow volume controller, Overcurrent device, power phase sequence device etc.				
Refrigerant	Type	R32			
	Chargeing volume kg	9.0		15.5	
Water pipe system	Water flow volume m ³ /h	9.8	12.0	17.2	22.4
	Rated water flow head m	23.0	17.3	18.0	11.7
	Water side heat exchanger	Plate heat exchanger			
	Max. pressure MPa	1.0			
	Min. pressure MPa	0.15			
	Inlet and outlet pipe dia.	DN50		DN65	
Air side heat exchanger	Type	Fin coil model			
	Air flow volume m ³ /h	22000	28500	32500	50000
Outline dimension N.W. of the unit	L mm	2000		2220	
	W mm	960		1135	
	H mm	1770		2300	
Net Weight	kg	475		746	
Operation Weight	kg	490		767	
Packing dimension	L × W × H mm	2085×1030×1890		2250×1180×2445	

13 INFORMATION REQUIREMENTS

Table 13-1

Information requirements for comfort chillers							
Model(s):	65KW						
Outdoor side heat exchanger of chiller:	Air						
Indoor side heat exchanger chiller:	Water						
Type:	Compressor driven vapour compression						
Driver of compressor:	Electric motor						
Item	Symbol	Value	Unit	Item	Symbol	Value	Unit
Rated cooling capacity	$P_{rated,c}$	57.00	kW	Seasonal space cooling energy efficiency	$\eta_{s,c}$	194.00	%
Declared cooling capacity for part load at given outdoor temperature T_j				Declared energy efficiency ratio for part load at given outdoor temperature T_j			
$T_j = + 35^\circ\text{C}$	P_{dc}	56.24	kW	$T_j = + 35^\circ\text{C}$	EER_d	2.90	--
$T_j = + 30^\circ\text{C}$	P_{dc}	42.40	kW	$T_j = + 30^\circ\text{C}$	EER_d	3.98	--
$T_j = + 25^\circ\text{C}$	P_{dc}	27.36	kW	$T_j = + 25^\circ\text{C}$	EER_d	5.43	--
$T_j = + 20^\circ\text{C}$	P_{dc}	19.35	kW	$T_j = + 20^\circ\text{C}$	EER_d	8.73	--
Degradation co-efficient for chillers (*)	C_{dc}	0.90	--				
Power consumption in modes other than 'active mode'							
Off mode	P_{OFF}	0.08	kW	Crankcase heater mode	P_{CK}	0	kW
Thermostat-off mode	P_{TO}	0.35	kW	Standby mode	P_{SB}	0.08	kW
Other items							
Capacity control	Variable			For air-to-water comfort chillers: air flow rate, outdoor measured	--	22000	m_3/h
Sound power level, indoors/outdoors	L_{WA}	--/83	dB	For water / brine-to-water chillers: Rated brine or water flow rate, outdoor side heat exchanger	--	--	m_3/h
Emissions of nitrogen oxides (if applicable)	$NO_x(**)$	--	mg/kWh input GCV				
GWP of the refrigerant	--	675	kg CO_2 eq (100 years)				
Standard rating conditions used:	Low temperature application						
Contact details	Sinclair Corporation, Ltd. 16 Great Queen Street, Covent Garden, WC2B 5AH LONDON United Kingdom						
(*) If C_{dc} is not determined by measurement then the default degradation coefficient of chillers shall be 0.9. (**) From 26 September 2018.							

Table 13-2

Information requirements for comfort chillers							
Model(s):	75KW						
Outdoor side heat exchanger of chiller:	Air						
Indoor side heat exchanger chiller:	Water						
Type:	Compressor driven vapour compression						
Driver of compressor:	Electric motor						
Item	Symbol	Value	Unit	Item	Symbol	Value	Unit
Rated cooling capacity	$P_{rated,c}$	70.00	kW	Seasonal space cooling energy efficiency	$\eta_{s,c}$	191.00	%
Declared cooling capacity for part load at given outdoor temperature T_j				Declared energy efficiency ratio for part load at given outdoor temperature T_j			
$T_j = +35^\circ\text{C}$	P_{dc}	69.32	kW	$T_j = +35^\circ\text{C}$	EER_d	2.59	--
$T_j = +30^\circ\text{C}$	P_{dc}	50.97	kW	$T_j = +30^\circ\text{C}$	EER_d	3.91	--
$T_j = +25^\circ\text{C}$	P_{dc}	32.28	kW	$T_j = +25^\circ\text{C}$	EER_d	5.44	--
$T_j = +20^\circ\text{C}$	P_{dc}	15.17	kW	$T_j = +20^\circ\text{C}$	EER_d	7.97	--
Degradation co-efficient for chillers (*)	C_{dc}	0.90	--				
Power consumption in modes other than 'active mode'							
Off mode	P_{OFF}	0.08	kW	Crankcase heater mode	P_{CK}	0	kW
Thermostat-off mode	P_{TO}	0.35	kW	Standby mode	P_{SB}	0.08	kW
Other items							
Capacity control	Variable			For air-to-water comfort chillers: air flow rate, outdoor measured	--	28500	m_3/h
Sound power level, indoors/outdoors	L_{WA}	--/89	dB	For water / brine-to-water chillers: Rated brine or water flow rate, outdoor side heat exchanger	--	--	m_3/h
Emissions of nitrogen oxides (if applicable)	$\text{NO}_x(**)$	--	mg/kWh input GCV				
GWP of the refrigerant	--	675	kg CO_2 eq (100 years)				
Standard rating conditions used:	Low temperature application						
Contact details	Sinclair Corporation, Ltd. 16 Great Queen Street, Covent Garden, WC2B 5AH LONDON United Kingdom						
(*) If C_{dc} is not determined by measurement then the default degradation coefficient of chillers shall be 0.9. (**) From 26 September 2018.							

Table 13-3

Information requirements for comfort chillers							
Model(s):	110KW						
Outdoor side heat exchanger of chiller:	Air						
Indoor side heat exchanger chiller:	Water						
Type:	Compressor driven vapour compression						
Driver of compressor:	Electric motor						
Item	Symbol	Value	Unit	Item	Symbol	Value	Unit
Rated cooling capacity	$P_{rated,c}$	100.00	kW	Seasonal space cooling energy efficiency	$\eta_{s,c}$	188.20	%
Declared cooling capacity for part load at given outdoor temperature T_j				Declared energy efficiency ratio for part load at given outdoor temperature T_j			
$T_j = + 35^\circ\text{C}$	P_{dc}	96.74	kW	$T_j = + 35^\circ\text{C}$	EER_d	2.87	--
$T_j = + 30^\circ\text{C}$	P_{dc}	77.53	kW	$T_j = + 30^\circ\text{C}$	EER_d	3.85	--
$T_j = + 25^\circ\text{C}$	P_{dc}	49.07	kW	$T_j = + 25^\circ\text{C}$	EER_d	5.74	--
$T_j = + 20^\circ\text{C}$	P_{dc}	29.55	kW	$T_j = + 20^\circ\text{C}$	EER_d	7.18	--
Degradation co-efficient for chillers (*)	C_{dc}	0.9	--				
Power consumption in modes other than 'active mode'							
Off mode	P_{OFF}	0.14	kW	Crankcase heater mode	P_{CK}	0	kW
Thermostat-off mode	P_{TO}	0.7	kW	Standby mode	P_{SB}	0.14	kW
Other items							
Capacity control	Variable			For air-to-water comfort chillers: air flow rate, outdoor measured	--	32500	m_3/h
Sound power level, indoors/outdoors	L_{WA}	--/83	dB	For water / brine-to-water chillers: Rated brine or water flow rate, outdoor side heat exchanger	--	--	m_3/h
Emissions of nitrogen oxides (if applicable)	$NO_x(**)$	--	mg/kWh input GCV				
GWP of the refrigerant	--	675	kg CO_2 eq (100 years)				
Standard rating conditions used:	Low temperature application						
Contact details	Sinclair Corporation, Ltd. 16 Great Queen Street, Covent Garden, WC2B 5AH LONDON United Kingdom						
(*) If C_{dc} is not determined by measurement then the default degradation coefficient of chillers shall be 0.9.							
(**) From 26 September 2018.							

Table 13-4

Information requirements for comfort chillers							
Model(s):	140KW						
Outdoor side heat exchanger of chiller:	Air						
Indoor side heat exchanger chiller:	Water						
Type:	Compressor driven vapour compression						
Driver of compressor:	Electric motor						
Item	Symbol	Value	Unit	Item	Symbol	Value	Unit
Rated cooling capacity	$P_{rated,c}$	130.00	kW	Seasonal space cooling energy efficiency	$\eta_{s,c}$	187.00	%
Declared cooling capacity for part load at given outdoor temperature T_j				Declared energy efficiency ratio for part load at given outdoor temperature T_j			
$T_j = + 35^\circ\text{C}$	P_{dc}	128.42	kW	$T_j = + 35^\circ\text{C}$	EER_d	2.55	--
$T_j = + 30^\circ\text{C}$	P_{dc}	95.95	kW	$T_j = + 30^\circ\text{C}$	EER_d	3.72	--
$T_j = + 25^\circ\text{C}$	P_{dc}	60.50	kW	$T_j = + 25^\circ\text{C}$	EER_d	5.50	--
$T_j = + 20^\circ\text{C}$	P_{dc}	29.55	kW	$T_j = + 20^\circ\text{C}$	EER_d	7.64	--
Degradation co-efficient for chillers (*)	C_{dc}	0.9	--				
Power consumption in modes other than 'active mode'							
Off mode	P_{OFF}	0.14	kW	Crankcase heater mode	P_{CK}	0	kW
Thermostat-off mode	P_{TO}	0.7	kW	Standby mode	P_{SB}	0.14	kW
Other items							
Capacity control	Variable			For air-to-water comfort chillers: air flow rate, outdoor measured	--	50000	m_3/h
Sound power level, indoors/outdoors	L_{WA}	--/93	dB	For water / brine-to-water chillers: Rated brine or water flow rate, outdoor side heat exchanger	--	--	m_3/h
Emissions of nitrogen oxides (if applicable)	$\text{NO}_x(**)$	--	mg/kWh input GCV				
GWP of the refrigerant	--	675	kg CO_2 eq (100 years)				
Standard rating conditions used:	Low temperature application						
Contact details	Sinclair Corporation, Ltd. 16 Great Queen Street, Covent Garden, WC2B 5AH LONDON United Kingdom						
(*) If C_{dc} is not determined by measurement then the default degradation coefficient of chillers shall be 0.9. (**) From 26 September 2018.							

Table 13-5

Information requirements for heat pump space heaters and heat pump combination heaters							
Model(s):	65KW&75KW						
Air-to-water heat pump:							[yes]
Water-to-water heat pump:							[yes/no]
Brine-to-water heat pump:							[yes/no]
Low-temperature heat pump:							[yes]
Equipped with a supplementary heater:							[yes/no]
Heat pump combination heater:							[yes/no]
In the table, the data are the parameters of the unit under the warmer climate conditions.							
Item	Symbol	Value	Unit	Item	Symbol	Value	Unit
Rated heat output ⁽³⁾ at T _{designh} = 2 (1) °C	Prated = P _{designh}	48.00	kW	Seasonal space heating energy efficiency	η _s	235.40	%
Seasonal coefficient of performance	SCOP	5.96	--	Active mode coef. of performance	SCOP _{on}	--	--
				Net seasonal coef. of performance	SCOP _{net}	--	--
T _j = -7°C	P _{dh}	--	kW	T _j = -7°C	COP _d	--	--
T _j = +2°C	P _{dh}	50.62	kW	T _j = +2°C	COP _d	3.23	--
T _j = +7°C	P _{dh}	30.57	kW	T _j = +7°C	COP _d	5.48	--
T _j = +12°C	P _{dh}	15.63	kW	T _j = +12°C	COP _d	7.50	--
T _j = bivalent temperature	P _{dh}	30.57	kW	T _j = bivalent temperature	COP _d	5.48	--
T _j = operation limit temperature	P _{dh}	50.62	kW	T _j =operation limit temperature	COP _d	3.23	--
For air-to-water heat pumps: T _j = - 15 °C (if TOL < - 20 °C)	P _{dh}	--	kW	For air-to-water heat pumps: T _j =-15°C (if TOL<-20°C)	COP _d	--	--
Bivalent temperature (maximum +2°C)	T _{biv}	7	°C	For air-to-water HP : Operation limit temperature (maximum-7°C)	TOL	2	°C
Cycling interval capacity for heating at T _j = -7°C	P _{cyh}	--	kW	Heating water operating limit temperature	WTOL	--	°C
Degradation co-efficient ⁽⁴⁾ at T= -7°C	C _{dh}	0.9	--	Cycling interval efficiency at T _j = +7°C	COP _{cyh}	--	--
Cycling interval capacity for heating at T _j =+2°C	P _{cyh}	--	kW	Cycling interval capacity for heating at T _j =+12°C	COP _{cyh}	--	--
Degradation coefficient ⁽⁴⁾ at T= +2°C	C _{dh}	--	--	Cycling interval efficiency at T _j = +7°C	COP _{cyh}	--	--
Cycling interval capacity for heating at T _j = +7°C	P _{cyh}	--	kW	Cycling interval capacity for heating at T _j =+12°C	COP _{cyh}	--	--
Degradation coefficient ⁽⁴⁾ at T _j = +7°C	C _{dh}	--	--	Supplementary heater (to be declared even if not provided in the unit)			
Cycling interval capacity for heating at T _j =+12°C	P _{cyh}	--	kW	Rated heat output(3)	P _{sup} = sup(T _j)	--	kW
Degradation coefficient ⁽⁴⁾ at T _j = +12°C	C _{dh}	--	--	Type of energy input			
Power consumption in modes other than active mode				Outdoor heat exchanger			
Off mode	P _{OFF}	0.08	kW	For air-to-water HP: Rated air flow rate	Q _{airsource}	22000 (65kW)	m ³ /h
Thermostat-off mode	P _{TO}	0.35	kW			28500 (75kW)	
Standby mode	P _{SB}	0.08	kW	For water-to-water: Rated water flow rate	Q _{watersource}	--	m ³ /h
Crankcase heater mode	P _{CK}	0	kW	For brine-to-water: Rated brine flow rate	Q _{brinesource}	--	m ³ /h
Other items							
Capacity control	Fixed/Variable	Variable					
Sound power level, indoors	L _{WA}	--	dB(A)				
Sound power level, outdoors	L _{WA}	83 (65kW)	dB(A)				
		89 (75kW)					
Contact details	Name and address of the manufacturer or its authorised representative.						
(1) For heat pump space heaters and heat pump combination heaters, the rated heat output Prated is equal to the design load for heating P _{designh} , and the rated heat output of a supplementary heater P _{sup} is equal to the supplementary capacity for heating sup(T _j).							
(2) If C _{dh} is not determined by measurement then the default degradation coefficient is C _{dh} = 0,9.							

Table 13-6

Information requirements for heat pump space heaters and heat pump combination heaters							
Model(s):	65KW&75KW						
Air-to-water heat pump:							[yes]
Water-to-water heat pump:							[yes/no]
Brine-to-water heat pump:							[yes/no]
Medium-temperature heat pump:							[yes]
Equipped with a supplementary heater:							[yes/no]
Heat pump combination heater:							[yes/no]
In the table, the data are the parameters of the unit under the warmer climate conditions .							
Item	Symbol	Value	Unit	Item	Symbol	Value	Unit
Rated heat output ⁽³⁾ at Tdesignh = 2 (1) °C	Prated = Pdesignh	40.00	kW	Seasonal space heating energy efficiency	η_s	159.00	%
Seasonal coefficient of performance	SCOP	4.05	--	Active mode coef. of performance	SCOP _{on}	--	--
				Net seasonal coef. of performance	SCOP _{net}	--	--
T _j = -7°C	Pdh	--	kW	T _j = -7°C	COPd	--	--
T _j = +2°C	Pdh	40.17	kW	T _j = +2°C	COPd	2.02	--
T _j = +7°C	Pdh	24.86	kW	T _j = +7°C	COPd	3.68	--
T _j = +12°C	Pdh	12.28	kW	T _j = +12°C	COPd	5.10	--
T _j = bivalent temperature	Pdh	24.86	kW	T _j = bivalent temperature	COPd	3.68	--
T _j = operation limit temperature	Pdh	40.17	kW	T _j =operation limit temperature	COPd	2.02	--
For air-to-water heat pumps: T _j = - 15 °C (if TOL < - 20 °C)	Pdh	--	kW	For air-to-water heat pumps: T _j =-15°C (if TOL<-20°C)	COPd	--	--
Bivalent temperature (maximum +2°C)	Tbiv	7	°C	For air-to-water HP : Operation limit temperature _(maximum-7°C)	TOL	2	°C
Cycling interval capacity for heating at T _j = -7°C	Pcych	--	kW	Heating water operating limit temperature	WTOL	--	°C
Degradation co-efficient ⁽⁴⁾ at T= -7°C	Cdh	0.9	--	Cycling interval efficiency at T _j = +7°C	COP _{cyc}	--	--
Cycling interval capacity for heating at T _j =+2°C	Pcych	--	kW	Cycling interval capacity for heating at T _j =+12°C	COP _{cyc}	--	--
Degradation coefficient ⁽⁴⁾ at T= +2°C	Cdh	--	--	Cycling interval efficiency at T _j = +7°C	COP _{cyc}	--	--
Cycling interval capacity for heating at T _j = +7°C	Pcych	--	kW	Cycling interval capacity for heating at T _j =+12°C	COP _{cyc}	--	--
Degradation coefficient ⁽⁴⁾ at T _j = +7°C	Cdh	--	--				
Cycling interval capacity for heating at T _j =+12°C	Pcych	--	kW				
Degradation coefficient ⁽⁴⁾ at T _j = +12°C	Cdh	--	--				
Power consumption in modes other than active mode				Supplementary heater (to be declared even if not provided in the unit)			
Off mode	P _{OFF}	0.08	kW	Rated heat output(3)	P _{sup} = sup(T _j)	--	kW
Thermostat-off mode	P _{TO}	0.35	kW	Type of energy input			
Standby mode	P _{SB}	0.08	kW	Outdoor heat exchanger			
Crankcase heater mode	P _{CK}	0	kW	For air-to-water HP: Rated air flow rate	Q _{airsource}	22000 (65kW) 28500 (75kW)	m ³ /h
Other items				For water-to-water: Rated water flow rate	Q _{watersource}	--	m ³ /h
Capacity control	Fixed/Variable	Variable		For brine-to-water: Rated brine flow rate	Q _{brinesource}	--	m ³ /h
Sound power level, indoors	L _{WA}	--	dB(A)				
Sound power level, outdoors	L _{WA}	83 (65kW)	dB(A)				
		89 (75kW)					
Contact details	Name and address of the manufacturer or its authorised representative.						
(1) For heat pump space heaters and heat pump combination heaters, the rated heat output Prated is equal to the design load for heating Pdesignh, and the rated heat output of a supplementary heater Psup is equal to the supplementary capacity for heating sup(T _j).							
(2) If Cdh is not determined by measurement then the default degradation coefficient is Cdh = 0,9.							

Table 13-7

Information requirements for heat pump space heaters and heat pump combination heaters							
Model(s):	65KW&75KW						
Air-to-water heat pump:							[yes]
Water-to-water heat pump:							[yes/no]
Brine-to-water heat pump:							[yes/no]
Low-temperature heat pump:							[yes]
Equipped with a supplementary heater:							[yes/no]
Heat pump combination heater:							[yes/no]
In the table, the data are the parameters of the unit under the average climate conditions .							
Item	Symbol	Value	Unit	Item	Symbol	Value	Unit
Rated heat output ⁽³⁾ at T _{designh} = -10 (-11) °C	P _{rated} = P _{designh}	48.00	kW	Seasonal space heating energy efficiency	η _s	175.80	%
Seasonal coefficient of performance	SCOP	4.47	--	Active mode coef. of performance	SCOP _{on}	--	--
				Net seasonal coef. of performance	SCOP _{net}	--	--
T _j = -7°C	P _{dh}	42.15	kW	T _j = -7°C	COP _d	3.25	--
T _j = +2°C	P _{dh}	24.57	kW	T _j = +2°C	COP _d	4.10	--
T _j = +7°C	P _{dh}	23.95	kW	T _j = +7°C	COP _d	6.17	--
T _j = +12°C	P _{dh}	20.62	kW	T _j = +12°C	COP _d	8.27	--
T _j = bivalent temperature	P _{dh}	42.15	kW	T _j = bivalent temperature	COP _d	3.25	--
T _j = operation limit temperature	P _{dh}	47.50	kW	T _j = operation limit temperature	COP _d	2.71	--
For air-to-water heat pumps: T _j = -15 °C (if TOL < -20 °C)	P _{dh}	--	kW	For air-to-water heat pumps: T _j = -15°C (if TOL < -20°C)	COP _d	--	--
Bivalent temperature (maximum +2°C)	T _{biv}	-7	°C	For air-to-water HP : Operation limit temperature _(maximum-7°C)	TOL	-10	°C
Cycling interval capacity for heating at T _j = -7°C	P _{cyh}	--	kW	Heating water operating limit temperature	WTOL	--	°C
Degradation co-efficient ⁽⁴⁾ at T = -7°C	C _{dh}	0.9	--	Cycling interval efficiency at T _j = +7°C	COP _{cyh}	--	--
Cycling interval capacity for heating at T _j = +2°C	P _{cyh}	--	kW	Cycling interval capacity for heating at T _j = +12°C	COP _{cyh}	--	--
Degradation coefficient ⁽⁴⁾ at T = +2°C	C _{dh}	--	--	Cycling interval efficiency at T _j = +7°C	COP _{cyh}	--	--
Cycling interval capacity for heating at T _j = +7°C	P _{cyh}	--	kW	Cycling interval capacity for heating at T _j = +12°C	COP _{cyh}	--	--
Degradation coefficient ⁽⁴⁾ at T _j = +7°C	C _{dh}	--	--	Supplementary heater (to be declared even if not provided in the unit)			
Cycling interval capacity for heating at T _j = +12°C	P _{cyh}	--	kW	Rated heat output ⁽³⁾	P _{sup} = sup(T _j)	--	kW
Degradation coefficient ⁽⁴⁾ at T _j = +12°C	C _{dh}	--	--	Type of energy input			
Power consumption in modes other than active mode				Outdoor heat exchanger			
Off mode	P _{OFF}	0.08	kW	For air-to-water HP: Rated air flow rate	Q _{airsource}	22000 (65kW)	m ³ /h
Thermostat-off mode	P _{TO}	0.35	kW			28500 (75kW)	
Standby mode	P _{SB}	0.08	kW	For water-to-water: Rated water flow rate	Q _{watersource}	--	m ³ /h
Crankcase heater mode	P _{CK}	0	kW	For brine-to-water: Rated brine flow rate	Q _{brinesource}	--	m ³ /h
Other items							
Capacity control	Fixed/Variable	Variable					
Sound power level, indoors	L _{WA}	--	dB(A)				
Sound power level, outdoors	L _{WA}	83 (65kW)	dB(A)				
		89 (75kW)					
Contact details	Name and address of the manufacturer or its authorised representative.						
(1) For heat pump space heaters and heat pump combination heaters, the rated heat output P _{rated} is equal to the design load for heating P _{designh} , and the rated heat output of a supplementary heater P _{sup} is equal to the supplementary capacity for heating sup(T _j).							
(2) If C _{dh} is not determined by measurement then the default degradation coefficient is C _{dh} = 0,9.							

Table 13-8

Information requirements for heat pump space heaters and heat pump combination heaters							
Model(s):	65KW&75KW						
Air-to-water heat pump:							[yes]
Water-to-water heat pump:							[yes/no]
Brine-to-water heat pump:							[yes/no]
Medium-temperature heat pump:							[yes]
Equipped with a supplementary heater:							[yes/no]
Heat pump combination heater:							[yes/no]
In the table, the data are the parameters of the unit under the average climate conditions .							
Item	Symbol	Value	Unit	Item	Symbol	Value	Unit
Rated heat output ⁽³⁾ at T _{designh} = -10 (-11) °C	P _{rated} = P _{designh}	40.00	kW	Seasonal space heating energy efficiency	η _s	131.40	%
Seasonal coefficient of performance	SCOP	3.36	--	Active mode coef. of performance	SCOP _{on}	--	--
				Net seasonal coef. of performance	SCOP _{net}	--	--
T _j = -7°C	P _{dh}	35.53	kW	T _j = -7°C	COP _d	2.43	--
T _j = +2°C	P _{dh}	21.55	kW	T _j = +2°C	COP _d	3.15	--
T _j = +7°C	P _{dh}	14.99	kW	T _j = +7°C	COP _d	4.35	--
T _j = +12°C	P _{dh}	18.37	kW	T _j = +12°C	COP _d	6.00	--
T _j = bivalent temperature	P _{dh}	35.53	kW	T _j = bivalent temperature	COP _d	2.43	--
T _j = operation limit temperature	P _{dh}	40.26	kW	T _j = operation limit temperature	COP _d	1.86	--
For air-to-water heat pumps: T _j = -15 °C (if TOL < -20 °C)	P _{dh}	--	kW	For air-to-water heat pumps: T _j = -15°C (if TOL < -20°C)	COP _d	--	--
Bivalent temperature (maximum +2°C)	T _{biv}	-7	°C	For air-to-water HP : Operation limit temperature _(maximum-7°C)	TOL	-10	°C
Cycling interval capacity for heating at T _j = -7°C	P _{cyh}	--	kW				
Degradation co-efficient ⁽⁴⁾ at T = -7°C	C _{dh}	0.9	--	Heating water operating limit temperature	WTOL	--	°C
Cycling interval capacity for heating at T _j = +2°C	P _{cyh}	--	kW	Cycling interval efficiency at T _j = +7°C	COP _{cyh}	--	--
Degradation coefficient ⁽⁴⁾ at T = +2°C	C _{dh}	--	--	Cycling interval capacity for heating at T _j = +12°C	COP _{cyh}	--	--
Cycling interval capacity for heating at T _j = +7°C	P _{cyh}	--	kW	Cycling interval efficiency at T _j = +7°C	COP _{cyh}	--	--
Degradation coefficient ⁽⁴⁾ at T _j = +7°C	C _{dh}	--	--	Cycling interval capacity for heating at T _j = +12°C	COP _{cyh}	--	--
Cycling interval capacity for heating at T _j = +12°C	P _{cyh}	--	kW	Supplementary heater (to be declared even if not provided in the unit)			
Degradation coefficient ⁽⁴⁾ at T _j = +12°C	C _{dh}	--	--				
Power consumption in modes other than active mode				Rated heat output(3)	P _{sup} = sup(T _j)	--	kW
Off mode	P _{OFF}	0.08	kW	Type of energy input			
Thermostat-off mode	P _{TO}	0.35	kW	Outdoor heat exchanger			
Standby mode	P _{SB}	0.08	kW				
Crankcase heater mode	P _{CK}	0	kW	For air-to-water HP: Rated air flow rate	Q _{airsource}	22000 (65kW)	m ³ /h
Other items							
Capacity control	Fixed/Variable	Variable		For water-to-water: Rated water flow rate	Q _{watersource}	--	m ³ /h
Sound power level, indoors	L _{WA}	--	dB(A)				
Sound power level, outdoors	L _{WA}	83 (65kW)	dB(A)	For brine-to-water: Rated brine flow rate	Q _{brinesource}	--	m ³ /h
		89 (75kW)					
Contact details	Name and address of the manufacturer or its authorised representative.						
(1) For heat pump space heaters and heat pump combination heaters, the rated heat output P _{rated} is equal to the design load for heating P _{designh} , and the rated heat output of a supplementary heater P _{sup} is equal to the supplementary capacity for heating sup(T _j).							
(2) If C _{dh} is not determined by measurement then the default degradation coefficient is C _{dh} = 0,9.							

Table 13-9

Information requirements for heat pump space heaters and heat pump combination heaters							
Model(s):	65KW&75KW						
Air-to-water heat pump:							[yes]
Water-to-water heat pump:							[yes/no]
Brine-to-water heat pump:							[yes/no]
Low-temperature heat pump:							[yes]
Equipped with a supplementary heater:							[yes/no]
Heat pump combination heater:							[yes/no]
In the table, the data are the parameters of the unit under the colder climate conditions .							
Item	Symbol	Value	Unit	Item	Symbol	Value	Unit
Rated heat output ⁽³⁾ at Tdesignh = -22 (--) °C	$P_{rated} = P_{designh}$	40.00	kW	Seasonal space heating energy efficiency	η_s	151.80	%
Seasonal coefficient of performance	SCOP	3.87	--	Active mode coef. of performance	SCOP _{on}	--	--
				Net seasonal coef. of performance	SCOP _{net}	--	--
T _j = -7°C	Pdh	24.52	kW	T _j = -7°C	COPd	3.12	--
T _j = +2°C	Pdh	15.51	kW	T _j = +2°C	COPd	4.62	--
T _j = +7°C	Pdh	12.54	kW	T _j = +7°C	COPd	5.57	--
T _j = +12°C	Pdh	15.24	kW	T _j = +12°C	COPd	7.52	--
T _j = bivalent temperature	Pdh	32.73	kW	T _j = bivalent temperature	COPd	2.73	--
T _j = operation limit temperature	Pdh	37.16	kW	T _j =operation limit temperature	COPd	1.97	--
For air-to-water heat pumps: T _j = -15 °C (if TOL < -20 °C)	Pdh	32.73	kW	For air-to-water heat pumps: T _j =-15°C (if TOL<-20°C)	COPd	2.73	--
Bivalent temperature (maximum +2°C)	Tbiv	-15	°C	For air-to-water HP : Operation limit temperature _(maximum-7°C)	TOL	-22	°C
Cycling interval capacity for heating at T _j = -7°C	Pcych	--	kW	Heating water operating limit temperature	WTOL	--	°C
Degradation co-efficient ⁽⁴⁾ at T= -7°C	Cdh	0.9	--	Cycling interval efficiency at T _j = +7°C	COPcyc	--	--
Cycling interval capacity for heating at T _j =+2°C	Pcych	--	kW	Cycling interval capacity for heating at T _j =+12°C	COPcyc	--	--
Degradation coefficient ⁽⁴⁾ at T= +2°C	Cdh	--	--	Cycling interval efficiency at T _j = +7°C	COPcyc	--	--
Cycling interval capacity for heating at T _j = +7°C	Pcych	--	kW	Cycling interval capacity for heating at T _j =+12°C	COPcyc	--	--
Degradation coefficient ⁽⁴⁾ at T _j = +7°C	Cdh	--	--				
Cycling interval capacity for heating at T _j =+12°C	Pcych	--	kW				
Degradation coefficient ⁽⁴⁾ at T _j = +12°C	Cdh	--	--				
Power consumption in modes other than active mode				Supplementary heater (to be declared even if not provided in the unit)			
Off mode	P _{OFF}	0.08	kW	Rated heat output(3)	P _{sup} = sup(T _j)	--	kW
Thermostat-off mode	P _{TO}	0.35	kW	Type of energy input			
Standby mode	P _{SB}	0.08	kW	Outdoor heat exchanger			
Crankcase heater mode	P _{CK}	0	kW	For air-to-water HP: Rated air flow rate	Q _{airsource}	22000 (65kW) 28500 (75kW)	m ³ /h
Other items				For water-to-water: Rated water flow rate	Q _{watersource}	--	m ³ /h
Capacity control	Fixed/Variable	Variable		For brine-to-water: Rated brine flow rate	Q _{brinesource}	--	m ³ /h
Sound power level, indoors	L _{WA}	--	dB(A)				
Sound power level, outdoors	L _{WA}	83 (65kW)	dB(A)				
		89 (75kW)					
Contact details	Name and address of the manufacturer or its authorised representative.						
(1) For heat pump space heaters and heat pump combination heaters, the rated heat output Prated is equal to the design load for heating Pdesignh, and the rated heat output of a supplementary heater Psup is equal to the supplementary capacity for heating sup(Tj).							
(2) If Cdh is not determined by measurement then the default degradation coefficient is Cdh = 0,9.							

Table 13-10

Information requirements for heat pump space heaters and heat pump combination heaters							
Model(s):	65KW&75KW						
Air-to-water heat pump:							[yes]
Water-to-water heat pump:							[yes/no]
Brine-to-water heat pump:							[yes/no]
Medium-temperature heat pump:							[yes]
Equipped with a supplementary heater:							[yes/no]
Heat pump combination heater:							[yes/no]
In the table, the data are the parameters of the unit under the colder climate conditions .							
Item	Symbol	Value	Unit	Item	Symbol	Value	Unit
Rated heat output ⁽³⁾ at T _{designh} = -22 (–) °C	P _{rated} = P _{designh}	34.00	kW	Seasonal space heating energy efficiency	η _s	103.80	%
Seasonal coefficient of performance	SCOP	2.67	--	Active mode coef. of performance	SCOP _{on}	--	--
				Net seasonal coef. of performance	SCOP _{net}	--	--
T _j = -7°C	P _{dh}	21.46	kW	T _j = -7°C	COP _d	2.56	--
T _j = +2°C	P _{dh}	12.23	kW	T _j = +2°C	COP _d	2.87	--
T _j = +7°C	P _{dh}	11.07	kW	T _j = +7°C	COP _d	3.75	--
T _j = +12°C	P _{dh}	14.21	kW	T _j = +12°C	COP _d	5.85	--
T _j = bivalent temperature	P _{dh}	27.81	kW	T _j = bivalent temperature	COP _d	1.81	--
T _j = operation limit temperature	P _{dh}	31.74	kW	T _j = operation limit temperature	COP _d	1.72	--
For air-to-water heat pumps: T _j = -15 °C (if TOL < -20 °C)	P _{dh}	27.81	kW	For air-to-water heat pumps: T _j = -15°C (if TOL < -20°C)	COP _d	1.81	--
Bivalent temperature (maximum +2°C)	T _{biv}	-15	°C	For air-to-water HP : Operation limit temperature (maximum -7°C)	TOL	-18	°C
Cycling interval capacity for heating at T _j = -7°C	P _{cyh}	--	kW	Heating water operating limit temperature	WTOL	--	°C
Degradation co-efficient ⁽⁴⁾ at T = -7°C	C _{dh}	0.9	--	Cycling interval efficiency at T _j = +7°C	COP _{cyh}	--	--
Cycling interval capacity for heating at T _j = +2°C	P _{cyh}	--	kW	Cycling interval capacity for heating at T _j = +12°C	COP _{cyh}	--	--
Degradation coefficient ⁽⁴⁾ at T = +2°C	C _{dh}	--	--	Cycling interval efficiency at T _j = +7°C	COP _{cyh}	--	--
Cycling interval capacity for heating at T _j = +7°C	P _{cyh}	--	kW	Cycling interval capacity for heating at T _j = +12°C	COP _{cyh}	--	--
Degradation coefficient ⁽⁴⁾ at T _j = +7°C	C _{dh}	--	--	Supplementary heater (to be declared even if not provided in the unit)			
Cycling interval capacity for heating at T _j = +12°C	P _{cyh}	--	kW				
Degradation coefficient ⁽⁴⁾ at T _j = +12°C	C _{dh}	--	--	Rated heat output ⁽³⁾	P _{sup} = sup(T _j)	--	kW
Power consumption in modes other than active mode				Type of energy input			
Off mode	P _{OFF}	0.08	kW	Outdoor heat exchanger			
Thermostat-off mode	P _{TO}	0.35	kW				
Standby mode	P _{SB}	0.08	kW	For air-to-water HP: Rated air flow rate	Q _{airsource}	22000 (65kW) 28500 (75kW)	m ³ /h
Crankcase heater mode	P _{CK}	0	kW	For water-to-water: Rated water flow rate	Q _{watersource}	--	m ³ /h
Other items				For brine-to-water: Rated brine flow rate	Q _{brinesource}	--	m ³ /h
				Capacity control	Fixed/Variable	Variable	
Sound power level, indoors	L _{WA}	--	dB(A)				
Sound power level, outdoors	L _{WA}	83 (65kW)	dB(A)				
		89 (75kW)					
Contact details	Name and address of the manufacturer or its authorised representative.						
(1) For heat pump space heaters and heat pump combination heaters, the rated heat output P _{rated} is equal to the design load for heating P _{designh} , and the rated heat output of a supplementary heater P _{sup} is equal to the supplementary capacity for heating sup(T _j).							
(2) If C _{dh} is not determined by measurement then the default degradation coefficient is C _{dh} = 0,9.							

Table 13-11

Information requirements for heat pump space heaters and heat pump combination heaters							
Model(s):	110KW&140KW						
Air-to-water heat pump:							[yes]
Water-to-water heat pump:							[yes/no]
Brine-to-water heat pump:							[yes/no]
Low-temperature heat pump:							[yes]
Equipped with a supplementary heater:							[yes/no]
Heat pump combination heater:							[yes/no]
In the table, the data are the parameters of the unit under the warmer climate conditions .							
Item	Symbol	Value	Unit	Item	Symbol	Value	Unit
Rated heat output ⁽³⁾ at Tdesignh = 2 (1) °C	Prated = Pdesignh	95.00	kW	Seasonal space heating energy efficiency	η_s	226.20	%
Seasonal coefficient of performance	SCOP	5.73	--	Active mode coef. of performance	SCOP _{on}	--	--
				Net seasonal coef. of performance	SCOP _{net}	--	--
T _j = -7°C	Pdh	--	kW	T _j = -7°C	COPd	--	--
T _j = +2°C	Pdh	93.90	kW	T _j = +2°C	COPd	2.87	--
T _j = +7°C	Pdh	61.08	kW	T _j = +7°C	COPd	5.00	--
T _j = +12°C	Pdh	32.07	kW	T _j = +12°C	COPd	7.80	--
T _j = bivalent temperature	Pdh	61.08	kW	T _j = bivalent temperature	COPd	5.00	--
T _j = operation limit temperature	Pdh	93.90	kW	T _j =operation limit temperature	COPd	2.87	--
For air-to-water heat pumps: T _j = -15 °C (if TOL < -20 °C)	Pdh	--	kW	For air-to-water heat pumps: T _j =-15°C (if TOL<-20°C)	COPd	--	--
Bivalent temperature (maximum +2°C)	Tbiv	7	°C	For air-to-water HP : Operation limit temperature (maximum-7°C)	TOL	2	°C
Cycling interval capacity for heating at T _j = -7°C	Pcych	--	kW	Heating water operating limit temperature	WTOL	--	°C
Degradation coefficient ⁽⁴⁾ at T = -7°C	Cdh	--	--	Cycling interval efficiency at T _j = +7°C	COP _{cyc}	--	--
Cycling interval capacity for heating at T _j =+2°C	Pcych	--	kW	Cycling interval capacity for heating at T _j =+12°C	COP _{cyc}	--	--
Degradation coefficient ⁽⁴⁾ at T = +2°C	Cdh	--	--	Cycling interval efficiency at T _j = +7°C	COP _{cyc}	--	--
Cycling interval capacity for heating at T _j = +7°C	Pcych	--	kW	Cycling interval capacity for heating at T _j =+12°C	COP _{cyc}	--	--
Degradation coefficient ⁽⁴⁾ at T _j = +7°C	Cdh	--	--	Supplementary heater (to be declared even if not provided in the unit)			
Cycling interval capacity for heating at T _j =+12°C	Pcych	--	kW	Rated heat output(3)	P _{sup} = sup(T _j)	--	kW
Degradation coefficient ⁽⁴⁾ at T _j = +12°C	Cdh	--	--	Type of energy input			
Power consumption in modes other than active mode				Outdoor heat exchanger			
Off mode	P _{OFF}	0.14	kW	For air-to-water HP: Rated air flow rate	Q _{airsource}	32500 (110kW) 50000 (140kW)	m ³ /h
Thermostat-off mode	P _{TO}	0.70	kW	For water-to-water: Rated water flow rate	Q _{watersource}	--	m ³ /h
Standby mode	P _{SB}	0.14	kW	For brine-to-water: Rated brine flow rate	Q _{brinesource}	--	m ³ /h
Crankcase heater mode	P _{CK}	0	kW				
Other items							
Capacity control	Fixed/Variable	Variable					
Sound power level, indoors	L _{WA}	--	dB(A)				
Sound power level, outdoors	L _{WA}	83 (110kW)	dB(A)				
		93 (140kW)					
Contact details	Name and address of the manufacturer or its authorised representative.						
(1) For heat pump space heaters and heat pump combination heaters, the rated heat output Prated is equal to the design load for heating Pdesignh, and the rated heat output of a supplementary heater Psup is equal to the supplementary capacity for heating sup(T _j).							
(2) If Cdh is not determined by measurement then the default degradation coefficient is Cdh = 0,9.							

Table 13-12

Information requirements for heat pump space heaters and heat pump combination heaters							
Model(s):	110KW&140KW						
Air-to-water heat pump:							[yes]
Water-to-water heat pump:							[yes/no]
Brine-to-water heat pump:							[yes/no]
Medium-temperature heat pump:							[yes]
Equipped with a supplementary heater:							[yes/no]
Heat pump combination heater:							[yes/no]
In the table, the data are the parameters of the unit under the warmer climate conditions .							
Item	Symbol	Value	Unit	Item	Symbol	Value	Unit
Rated heat output ⁽³⁾ at T _{designh} = 2 (1) °C	$P_{rated} = P_{designh}$	80.00	kW	Seasonal space heating energy efficiency	η_s	165.80	%
Seasonal coefficient of performance	SCOP	4.22	--	Active mode coef. of performance	SCOP _{on}	--	--
				Net seasonal coef. of performance	SCOP _{net}	--	--
T _j = -7°C	P _{dh}	--	kW	T _j = -7°C	COP _d	--	--
T _j = +2°C	P _{dh}	84.90	kW	T _j = +2°C	COP _d	2.04	--
T _j = +7°C	P _{dh}	52.14	kW	T _j = +7°C	COP _d	3.84	--
T _j = +12°C	P _{dh}	31.02	kW	T _j = +12°C	COP _d	5.55	--
T _j = bivalent temperature	P _{dh}	52.14	kW	T _j = bivalent temperature	COP _d	3.84	--
T _j = operation limit temperature	P _{dh}	84.90	kW	T _j = operation limit temperature	COP _d	2.04	--
For air-to-water heat pumps: T _j = -15 °C (if TOL < -20 °C)	P _{dh}	--	kW	For air-to-water heat pumps: T _j = -15°C (if TOL < -20°C)	COP _d	--	--
Bivalent temperature (maximum +2°C)	T _{biv}	7	°C	For air-to-water HP : Operation limit temperature (maximum -7°C)	TOL	2	°C
Cycling interval capacity for heating at T _j = -7°C	P _{cyh}	--	kW	Heating water operating limit temperature	WTOL	--	°C
Degradation coefficient ⁽⁴⁾ at T = -7°C	C _{dh}	--	--	Cycling interval efficiency at T _j = +7°C	COP _{cyh}	--	--
Cycling interval capacity for heating at T _j = +2°C	P _{cyh}	--	kW	Cycling interval capacity for heating at T _j = +12°C	COP _{cyh}	--	--
Degradation coefficient ⁽⁴⁾ at T = +2°C	C _{dh}	--	--	Cycling interval efficiency at T _j = +7°C	COP _{cyh}	--	--
Cycling interval capacity for heating at T _j = +7°C	P _{cyh}	--	kW	Cycling interval capacity for heating at T _j = +12°C	COP _{cyh}	--	--
Degradation coefficient ⁽⁴⁾ at T _j = +7°C	C _{dh}	--	--	Supplementary heater (to be declared even if not provided in the unit)			
Cycling interval capacity for heating at T _j = +12°C	P _{cyh}	--	kW				
Degradation coefficient ⁽⁴⁾ at T _j = +12°C	C _{dh}	--	--	Rated heat output(3)	P _{sup} = sup(T _j)	--	kW
Power consumption in modes other than active mode				Outdoor heat exchanger			
Off mode	P _{OFF}	0.14	kW	For air-to-water HP: Rated air flow rate	Q _{airsource}	32500 (110kW) 50000 (140kW)	m ³ /h
Thermostat-off mode	P _{TO}	0.70	kW	For water-to-water: Rated water flow rate	Q _{watersource}	--	m ³ /h
Standby mode	P _{SB}	0.14	kW	For brine-to-water: Rated brine flow rate	Q _{brinesource}	--	m ³ /h
Crankcase heater mode	P _{CK}	0	kW				
Other items							
Capacity control	Fixed/Variable	Variable					
Sound power level, indoors	L _{WA}	--	dB(A)				
Sound power level, outdoors	L _{WA}	83 (110kW)	dB(A)				
		93 (140kW)					
Contact details	Name and address of the manufacturer or its authorised representative.						
(1) For heat pump space heaters and heat pump combination heaters, the rated heat output P _{rated} is equal to the design load for heating P _{designh} , and the rated heat output of a supplementary heater P _{sup} is equal to the supplementary capacity for heating sup(T _j).							
(2) If C _{dh} is not determined by measurement then the default degradation coefficient is C _{dh} = 0,9.							

Table 13-13

Information requirements for heat pump space heaters and heat pump combination heaters							
Model(s):	110KW&140KW						
Air-to-water heat pump:							[yes]
Water-to-water heat pump:							[yes/no]
Brine-to-water heat pump:							[yes/no]
Low-temperature heat pump:							[yes]
Equipped with a supplementary heater:							[yes/no]
Heat pump combination heater:							[yes/no]
In the table, the data are the parameters of the unit under the average climate conditions .							
Item	Symbol	Value	Unit	Item	Symbol	Value	Unit
Rated heat output ⁽³⁾ at T _{designh} = -10 (-11) °C	P _{rated} = P _{designh}	95.00	kW	Seasonal space heating energy efficiency	η _s	166.20	%
Seasonal coefficient of performance	SCOP	4.23	--	Active mode coef. of performance	SCOP _{on}	--	--
				Net seasonal coef. of performance	SCOP _{net}	--	--
T _j = -7°C	P _d	85.48	kW	T _j = -7°C	COP _d	2.99	--
T _j = +2°C	P _d	49.88	kW	T _j = +2°C	COP _d	3.72	--
T _j = +7°C	P _d	33.76	kW	T _j = +7°C	COP _d	6.24	--
T _j = +12°C	P _d	39.22	kW	T _j = +12°C	COP _d	7.94	--
T _j = bivalent temperature	P _d	85.48	kW	T _j = bivalent temperature	COP _d	2.99	--
T _j = operation limit temperature	P _d	94.65	kW	T _j = operation limit temperature	COP _d	2.37	--
For air-to-water heat pumps: T _j = -15 °C (if TOL < -20 °C)	P _d	--	kW	For air-to-water heat pumps: T _j = -15°C (if TOL < -20°C)	COP _d	--	--
Bivalent temperature (maximum +2°C)	T _{biv}	-7	°C	For air-to-water HP : Operation limit temperature (maximum -7°C)	TOL	-10	°C
Cycling interval capacity for heating at T _j = -7°C	P _{cyh}	--	kW	Heating water operating limit temperature	WTOL	--	°C
Degradation coefficient ⁽⁴⁾ at T = -7°C	C _d	--	--	Cycling interval efficiency at T _j = +7°C	COP _{cyh}	--	--
Cycling interval capacity for heating at T _j = +2°C	P _{cyh}	--	kW	Cycling interval capacity for heating at T _j = +12°C	COP _{cyh}	--	--
Degradation coefficient ⁽⁴⁾ at T = +2°C	C _d	--	--	Cycling interval efficiency at T _j = +7°C	COP _{cyh}	--	--
Cycling interval capacity for heating at T _j = +7°C	P _{cyh}	--	kW	Cycling interval capacity for heating at T _j = +12°C	COP _{cyh}	--	--
Degradation coefficient ⁽⁴⁾ at T _j = +7°C	C _d	--	--	Supplementary heater (to be declared even if not provided in the unit)			
Cycling interval capacity for heating at T _j = +12°C	P _{cyh}	--	kW				
Degradation coefficient ⁽⁴⁾ at T _j = +12°C	C _d	--	--	Rated heat output ⁽³⁾	P _{sup} = sup(T _j)	--	kW
Power consumption in modes other than active mode				Outdoor heat exchanger			
Off mode	P _{OFF}	0.14	kW	For air-to-water HP: Rated air flow rate	Q _{airsource}	32500 (110kW) 50000 (140kW)	m ³ /h
Thermostat-off mode	P _{TO}	0.70	kW	For water-to-water: Rated water flow rate	Q _{watersource}	--	m ³ /h
Standby mode	P _{SB}	0.14	kW	For brine-to-water: Rated brine flow rate	Q _{brinesource}	--	m ³ /h
Crankcase heater mode	P _{CK}	0	kW				
Other items							
Capacity control	Fixed/Variable	Variable					
Sound power level, indoors	L _{WA}	--	dB(A)				
Sound power level, outdoors	L _{WA}	83 (110kW)	dB(A)				
		93 (140kW)					
Contact details	Name and address of the manufacturer or its authorised representative.						
(1) For heat pump space heaters and heat pump combination heaters, the rated heat output P _{rated} is equal to the design load for heating P _{designh} , and the rated heat output of a supplementary heater P _{sup} is equal to the supplementary capacity for heating sup(T _j).							
(2) If C _d is not determined by measurement then the default degradation coefficient is C _d = 0,9.							

Table 13-14

Information requirements for heat pump space heaters and heat pump combination heaters							
Model(s):	110KW&140KW						
Air-to-water heat pump:							[yes]
Water-to-water heat pump:							[yes/no]
Brine-to-water heat pump:							[yes/no]
Medium-temperature heat pump:							[yes]
Equipped with a supplementary heater:							[yes/no]
Heat pump combination heater:							[yes/no]
In the table, the data are the parameters of the unit under the average climate conditions .							
Item	Symbol	Value	Unit	Item	Symbol	Value	Unit
Rated heat output ⁽³⁾ at T _{designh} = -10 (-11) °C	Prated = P _{designh}	80.00	kW	Seasonal space heating energy efficiency	η _s	126.20	%
Seasonal coefficient of performance	SCOP	3.23	--	Active mode coef. of performance	SCOP _{on}	--	--
				Net seasonal coef. of performance	SCOP _{net}	--	--
T _j = -7°C	P _d	69.25	kW	T _j = -7°C	COP _d	2.01	--
T _j = +2°C	P _d	41.90	kW	T _j = +2°C	COP _d	3.10	--
T _j = +7°C	P _d	28.17	kW	T _j = +7°C	COP _d	4.40	--
T _j = +12°C	P _d	37.89	kW	T _j = +12°C	COP _d	6.07	--
T _j = bivalent temperature	P _d	69.25	kW	T _j = bivalent temperature	COP _d	2.01	--
T _j = operation limit temperature	P _d	79.73	kW	T _j =operation limit temperature	COP _d	1.76	--
For air-to-water heat pumps: T _j = -15 °C (if TOL < -20 °C)	P _d	--	kW	For air-to-water heat pumps: T _j =-15°C (if TOL<-20°C)	COP _d	--	--
Bivalent temperature (maximum +2°C)	T _{biv}	-7	°C	For air-to-water HP : Operation limit temperature _(maximum-7°C)	TOL	-10	°C
Cycling interval capacity for heating at T _j = -7°C	P _{cy}	--	kW	Heating water operating limit temperature	WTOL	--	°C
Degradation coefficient ⁽⁴⁾ at T = -7°C	C _d	--	--	Cycling interval efficiency at T _j = +7°C	COP _{cy}	--	--
Cycling interval capacity for heating at T _j =+2°C	P _{cy}	--	kW	Cycling interval capacity for heating at T _j =+12°C	COP _{cy}	--	--
Degradation coefficient ⁽⁴⁾ at T = +2°C	C _d	--	--	Cycling interval efficiency at T _j = +7°C	COP _{cy}	--	--
Cycling interval capacity for heating at T _j = +7°C	P _{cy}	--	kW	Cycling interval capacity for heating at T _j =+12°C	COP _{cy}	--	--
Degradation coefficient ⁽⁴⁾ at T _j = +7°C	C _d	--	--	Supplementary heater (to be declared even if not provided in the unit)			
Cycling interval capacity for heating at T _j =+12°C	P _{cy}	--	kW				
Degradation coefficient ⁽⁴⁾ at T _j = +12°C	C _d	--	--	Rated heat output(3)	P _{sup} = sup(T _j)	--	kW
Power consumption in modes other than active mode				Type of energy input			
Off mode	P _{OFF}	0.14	kW	Outdoor heat exchanger			
Thermostat-off mode	P _{TO}	0.70	kW	For air-to-water HP: Rated air flow rate	Q _{airsource}	32500 (110kW)	m ³ /h
Standby mode	P _{SB}	0.14	kW			50000 (140kW)	
Crankcase heater mode	P _{CK}	0	kW	For water-to-water: Rated water flow rate	Q _{watersource}	--	m ³ /h
Other items				For brine-to-water: Rated brine flow rate	Q _{brinesource}	--	m ³ /h
Capacity control	Fixed/Variable	Variable		Supplementary heater (to be declared even if not provided in the unit)			
Sound power level, indoors	L _{WA}	--	dB(A)	Rated heat output(3)			
Sound power level, outdoors	L _{WA}	83 (110kW)	dB(A)	Type of energy input			
		93 (140kW)		Outdoor heat exchanger			
Contact details	Name and address of the manufacturer or its authorised representative.						

(1) For heat pump space heaters and heat pump combination heaters, the rated heat output Prated is equal to the design load for heating P_{designh}, and the rated heat output of a supplementary heater P_{sup} is equal to the supplementary capacity for heating sup(T_j).

(2) If C_d is not determined by measurement then the default degradation coefficient is C_d = 0,9.

Table 13-15

Information requirements for heat pump space heaters and heat pump combination heaters							
Model(s):	110KW&140KW						
Air-to-water heat pump:							[yes]
Water-to-water heat pump:							[yes/no]
Brine-to-water heat pump:							[yes/no]
Low-temperature heat pump:							[yes]
Equipped with a supplementary heater:							[yes/no]
Heat pump combination heater:							[yes/no]
In the table, the data are the parameters of the unit under the colder climate conditions .							
Item	Symbol	Value	Unit	Item	Symbol	Value	Unit
Rated heat output ⁽³⁾ at T _{designh} = -22 (–) °C	P _{rated} = P _{designh}	80.00	kW	Seasonal space heating energy efficiency	η _s	144.60	%
Seasonal coefficient of performance	SCOP	3.69	--	Active mode coef. of performance	SCOP _{on}	--	--
				Net seasonal coef. of performance	SCOP _{net}	--	--
T _j = -7°C	P _d	47.10	kW	T _j = -7°C	COP _d	3.06	--
T _j = +2°C	P _d	29.30	kW	T _j = +2°C	COP _d	4.15	--
T _j = +7°C	P _d	27.39	kW	T _j = +7°C	COP _d	6.30	--
T _j = +12°C	P _d	32.18	kW	T _j = +12°C	COP _d	7.60	--
T _j = bivalent temperature	P _d	67.34	kW	T _j = bivalent temperature	COP _d	2.55	--
T _j = operation limit temperature	P _d	75.58	kW	T _j = operation limit temperature	COP _d	1.96	--
For air-to-water heat pumps: T _i = -15 °C (if TOL < -20 °C)	P _d	67.34	kW	For air-to-water heat pumps: T _i = -15°C (if TOL < -20°C)	COP _d	2.55	--
Bivalent temperature (maximum +2°C)	T _{biv}	-15	°C	For air-to-water HP : Operation limit temperature (maximum -7°C)	TOL	-22	°C
Cycling interval capacity for heating at T _j = -7°C	P _{cyh}	-	kW	Heating water operating limit temperature	WTOL	--	°C
Degradation coefficient ⁽⁴⁾ at T = -7°C	C _d	--	--	Cycling interval efficiency at T _j = +7°C	COP _{cyh}	--	--
Cycling interval capacity for heating at T _j = +2°C	P _{cyh}	--	kW	Cycling interval capacity for heating at T _j = +12°C	COP _{cyh}	--	--
Degradation coefficient ⁽⁴⁾ at T = +2°C	C _d	--	--	Cycling interval efficiency at T _j = +7°C	COP _{cyh}	--	--
Cycling interval capacity for heating at T _j = +7°C	P _{cyh}	--	kW	Cycling interval capacity for heating at T _j = +12°C	COP _{cyh}	--	--
Degradation coefficient ⁽⁴⁾ at T _j = +7°C	C _d	--	--				
Cycling interval capacity for heating at T _j = +12°C	P _{cyh}	--	kW				
Degradation coefficient ⁽⁴⁾ at T _j = +12°C	C _d	--	--				
Power consumption in modes other than active mode				Supplementary heater (to be declared even if not provided in the unit)			
Off mode	P _{OFF}	0.14	kW	Rated heat output ⁽³⁾	P _{sup} = sup(T _j)	--	kW
Thermostat-off mode	P _{TO}	0.70	kW	Type of energy input			
Standby mode	P _{SB}	0.14	kW	Outdoor heat exchanger			
Crankcase heater mode	P _{CK}	0	kW	For air-to-water HP: Rated air flow rate	Q _{airsource}	32500 (110kW) 50000 (140kW)	m ³ /h
Other items				For water-to-water: Rated water flow rate	Q _{watersource}	--	m ³ /h
Capacity control	Fixed/Variable	Variable		For brine-to-water: Rated brine flow rate	Q _{brinesource}	--	m ³ /h
Sound power level, indoors	L _{WA}	--	dB(A)				
Sound power level, outdoors	L _{WA}	83 (110kW)	dB(A)				
		93 (140kW)					
Contact details	Name and address of the manufacturer or its authorised representative.						
(1) For heat pump space heaters and heat pump combination heaters, the rated heat output P _{rated} is equal to the design load for heating P _{designh} , and the rated heat output of a supplementary heater P _{sup} is equal to the supplementary capacity for heating sup(T _j).							
(2) If C _d is not determined by measurement then the default degradation coefficient is C _d = 0,9.							

Table 13-16

Information requirements for heat pump space heaters and heat pump combination heaters							
Model(s):	110KW&140KW						
Air-to-water heat pump:							[yes]
Water-to-water heat pump:							[yes/no]
Brine-to-water heat pump:							[yes/no]
Medium-temperature heat pump:							[yes]
Equipped with a supplementary heater:							[yes/no]
Heat pump combination heater:							[yes/no]
Fln the table, the data are the parameters of the unit under the colder climate conditions .							
Item	Symbol	Value	Unit	Item	Symbol	Value	Unit
Rated heat output ⁽³⁾ at Tdesignh = -22 (--) °C	Prated = Pdesignh	68.00	kW	Seasonal space heating energy efficiency	η_s	107.40	%
Seasonal coefficient of performance	SCOP	2.76	--	Active mode coef. of performance	SCOP _{on}	--	--
				Net seasonal coef. of performance	SCOP _{net}	--	--
T _j = -7°C	Pdh	43.60	kW	T _j = -7°C	COPd	2.50	--
T _j = +2°C	Pdh	25.32	kW	T _j = +2°C	COPd	3.01	--
T _j = +7°C	Pdh	25.48	kW	T _j = +7°C	COPd	4.50	--
T _j = +12°C	Pdh	31.43	kW	T _j = +12°C	COPd	6.30	--
T _j = bivalent temperature	Pdh	56.06	kW	T _j = bivalent temperature	COPd	1.86	--
T _j = operation limit temperature	Pdh	60.98	kW	T _j =operation limit temperature	COPd	1.80	--
For air-to-water heat pumps: T _j = -15 °C (if TOL < -20 °C)	Pdh	56.06	kW	For air-to-water heat pumps: T _j =-15°C (if TOL<-20°C)	COPd	1.86	--
Bivalent temperature (maximum +2°C)	Tbiv	-15	°C	For air-to-water HP : Operation limit temperature _(maximum-7°C)	TOL	-18	°C
Cycling interval capacity for heating at T _j = -7°C	Pcych	--	kW	Heating water operating limit temperature	WTOL	--	°C
Degradation coefficient ⁽⁴⁾ at T= -7°C	Cdh	--	--	Cycling interval efficiency at T _j = +7°C	COP _{pcyc}	--	--
Cycling interval capacity for heating at T _j =+2°C	Pcych	--	kW	Cycling interval capacity for heating at T _j =+12°C	COP _{pcyc}	--	--
Degradation coefficient ⁽⁴⁾ at T= +2°C	Cdh	--	--	Cycling interval efficiency at T _j = +7°C	COP _{pcyc}	--	--
Cycling interval capacity for heating at T _j = +7°C	Pcych	--	kW	Cycling interval capacity for heating at T _j =+12°C	COP _{pcyc}	--	--
Degradation coefficient ⁽⁴⁾ at T _j = +7°C	Cdh	--	--	Supplementary heater (to be declared even if not provided in the unit)			
Cycling interval capacity for heating at T _j =+12°C	Pcych	--	kW				
Degradation coefficient ⁽⁴⁾ at T _j = +12°C	Cdh	--	--	Rated heat output(3)	P _{sup} = sup(T _j)	--	kW
Power consumption in modes other than active mode				Type of energy input	Outdoor heat exchanger		
Off mode	P _{OFF}	0.14	kW	For air-to-water HP: Rated air flow rate	Q _{airsource}	32500 (110kW) 50000 (140kW)	m ³ /h
Thermostat-off mode	P _{TO}	0.70	kW	For water-to-water: Rated water flow rate	Q _{watersource}	--	m ³ /h
Standby mode	P _{SB}	0.14	kW	For brine-to-water: Rated brine flow rate	Q _{brinesource}	--	m ³ /h
Crankcase heater mode	P _{CK}	0	kW				
Other items							
Capacity control	Fixed/Variable	Variable					
Sound power level, indoors	L _{WA}	--	dB(A)				
Sound power level, outdoors	L _{WA}	83 (110kW)	dB(A)				
		93 (140kW)					
Contact details	Name and address of the manufacturer or its authorised representative.						
(1) For heat pump space heaters and heat pump combination heaters, the rated heat output Prated is equal to the design load for heating Pdesignh, and the rated heat output of a supplementary heater Psup is equal to the supplementary capacity for heating sup(Tj).							
(2) If Cdh is not determined by measurement then the default degradation coefficient is Cdh = 0,9.							

NOTE CONCERNING PROTECTION OF ENVIRONMENT



This product must not be disposed of via normal household waste after its service life, but must be taken to a collection station for the recycling of electrical and electronic devices. The symbol on the product, the operating instructions or the packaging indicate such disposal procedures. The materials are recyclable in accordance with their respective symbols. By means of re-use, material recycling or any other form of recycling old appliances you are making an important contribution to the protection of our environment. Please ask your local council where your nearest disposal station is located.

INFORMATION CONCERNING USED REFRIGERANT MEDIUM

This unit is containing fluorinated gases included in the Kyoto protocol.
The maintenance and the liquidation must be carried out by qualified personnel.

Type of refrigerant: R32

The quantity of the refrigerant: Please see the unit label.

The value GWP: 675 (1 kg R32 = 0,675 t CO₂ eq)

GWP = Global Warming Potential



Appliance filled with flammable gas R32.

In case of quality problem or other please contact your local supplier or authorized service center.

Emergency number: 112

PRODUCER

SINCLAIR CORPORATION Ltd.
16 Great Queen Street
WC2B 5AH London
United Kingdom
www.sinclair-world.com

This product was manufactured in China (Made in China).

REPRESENTATIVE

SINCLAIR Global Group s.r.o.
Purkynova 45
612 00 Brno
Czech Republic

TECHNICAL SUPPORT

SINCLAIR Global Group s.r.o.
Purkynova 45
612 00 Brno
Czech Republic
Tel.: +420 800 100 285 | Fax: +420 541 590 124
www.sinclair-solutions.com | info@sinclair-solutions.com



16127100A11070 V1.0