

EN

WIRE CONTROLLER

INSTALLATION AND USER MANUAL

KJR-90D

“Original instructions”

Thank you very much for purchasing our product.
Before using your unit, please read this manual carefully and keep it for future reference.



- This manual gives detailed description of the precautions that should be brought to your attention during operation.
- In order to ensure correct service of the wired controller please read this manual carefully before using the unit.
- For convenience of future reference, keep this manual after reading it.

CONTENTS

OPERATION	2
1 Operation precautions.....	2
2 Operation conditions.....	2
3 Main functions.....	2
4 Wired remote controller outlook.....	3
5 Operation instructions.....	4
6 Technique certification and requirement.....	6
INSTALLATION	7
1 Safety precautions.....	7
2 Installation accessory.....	7
3 Installation methods.....	8
4 Wiring diagrams with air conditioning indoor units.....	10

OPERATION

- Read the safety precautions carefully before installing, must be obeyed.

Identifier	Meaning
 Warning	Means improper handling may lead to personal death or severe injury.
 Caution	Means improper handling may lead to personal injury or property loss.

- This manual uses the following icons:



Prohibit



Follow the guidelines

- Please entrust the distributor or professionals to install the unit.
- Before cleaning or maintenance please cut off the power.
- Prohibit to use water for washing to prevent electrical shock.
- Do not operate by wet hand, to prevent electrical shock.
- Do not use pesticide, disinfectant and flammability spray materials to spray directly, otherwise will cause fire or deformation.
- Do not peel off the button and the cover by hand to prevent electrical shock.

Operation conditions

Voltage input	5V DC
Ambient temperature range	-15-43 °C
Ambient humidity range	40-90 % RH
Electric control safety meets	GB4706.32-2004, GB/T7725-2004

Main functions

- Connect to the indoor unit display panel through the 5-core shielding cable
- Through the button operations to set the action mode.
- Liquid crystal display function.

Wired remote controller outlook

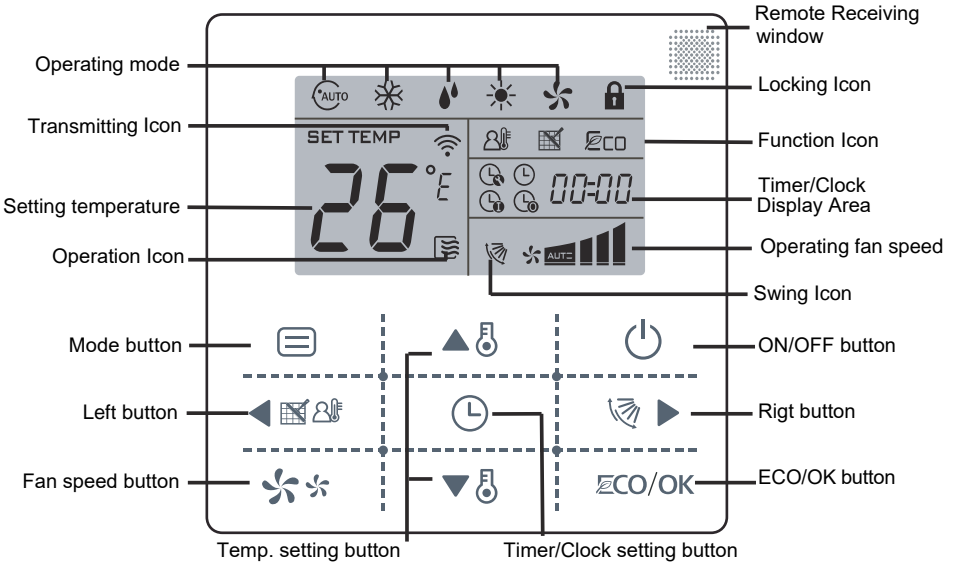

⚠ Caution: Do not peel off the buttons and liquid crystal cover to prevent shock!

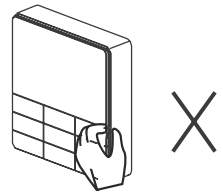

OPERATION INSTRUCTIONS

Remote signal receiving function

The wired remote controller can be a remote signal receiving device, you can use the wireless remote controller to control the air-conditioner through the wired remote controller when the system have been powered on.

CAUTION

The wired remote controller will not receive the swing controlling instruction. For the indoor unit with swinging function, you can directly use the wireless remote controller to control swinging through the display panel of the indoor unit or use the swing button on the wired remote controller to control the indoor unit for swinging.

On and Off the air-conditioner





Press the On/Off button to control the indoor unit turn on and turn off status.

When the unit is turned off, press the On/Off button, the unit will be turned on and the operating icon lights up .

When the unit is turned on, press the On/Off button, the unit will be turned off and the operating icon  lights off.

Set the operating mode

Press the mode button to set the operating mode, after each button press the operation mode will circle as follow:

AUTO  → COOL  →
DRY  → HEAT  →
FAN  → AUTO

When the controller has been set to cool-only, then there is no HEAT mode.

Fan speed setting

Under COOL, HEAT and FAN modes, press the fan speed button can adjust the fan speed setting. After each fan speed button press will circle as follow:

AUTO → LOW → MID →
→ HIGH → AUTO



Under Auto and Dry modes the fan speed is not adjustable and the default fan speed is AUTO.

Temperature setting

Under AUTO, COOL, DRY, HEAT modes, press the temperature setting buttons and to set the temperature, the adjusting range is 17°C- 30°C (or 62°F-88°F)

The setting temperature cannot be adjusted under FAN mode.

Timer on and Timer off setting

Press the timer/clock setting button, then enter into the timer on setting status and the screen will display  and . Press temperature setting button to adjust the timer. When the timer setting is less than 10 hours, each press will increase or decrease 0,5 hour.

When the timer setting is more than 10 hours, each press of temperature setting buttons will increase or decrease 1 hour. The maximum timer setting is 24 hours.

After finish adjusting the timer on setting, press the  button or wait for 5 seconds to confirm and exit the timer on setting.

Under the timer on setting status, press the timer/clock setting button, then enter into the timer off setting status and the screen will display  and

Under ECO operation, the initial fan speed is auto and the setpoint is 26°C for COOL mode and 22°C for HEAT mode.

The setting method of timer off is the same as the timer on.

ECO operation is available only when the IDU equipped with this function.

Under timer setting state, set the timer on and timer off to be 0.0 h can cancel timer on and timer off.

Lock the wired remote controller

Press the temperature adjusting buttons simultaneously, the wired remote controller enters into locking state and the locking icon  will be lighted up.

Under the locking state, the wired controller will not respond to the buttons pressing and the control instruction from the wireless remote controller.

Simultaneously press the temperature adjusting buttons again can cancel the locking state.



CAUTION

If the wired remote controller has been set timer on/off, press the ON/OFF to turn on/turn off the unit - then the timer will be canceled simultaneously.

Clock setting

Long press the timer/ clock setting button for 3 seconds, then enter into the clock setting status.

The hour position of the clock will flash and can press temperature setting button to adjust the hour value.

After finishing the hour setting, press left button  or right button  to switch to minute position setting, then the minute position will flash press temperature setting button .

After finish the clock setting, press the  button or wait for 5 seconds to confirm and exit the setting state.

ECO operation

Press the  button to enter ECO operation when the unit is turned on and is cooling or heating.

Air filter cleaning reminding function



The wired remote controller records the total running time of the indoor unit, when the accumulated running time reaches the pre-setted value, the air filter cleaning reminding icon will be lighted up, to remind that the air filter of the indoor unit need to be reminding icon will be lighted up, to remind that the air filter of the indoor unit need to be cleaned .

Long press of  for 3 seconds and reset the reminding icon and the wired remote controller will re-accumulate the total running time of the indoor unit.



CAUTION

The default setting value of the reminding function is 2500 hours and it can change to be 1250 hours, 5000 hours or 10000 hours. The setting methods please refer to the installation manual.

Swing function

If the indoor unit supports swing function, press the right button  to adjust the air outlet direction of the indoor unit. Long press this button for 3 seconds can turn on or turn off the auto swing function, the swing icon  will be lighted up when the auto swing function is turned on.

Follow Me function

When the system is running and the operating mode is AUTO, COOL or HEAT, press the  button will activate the Follow Me function, press this button again to deactivate the function. 

Operating mode changeover will deactivate the function as well.

When the Follow me function is activated, the icon  will be light up, the wired remote controller will display room temperature read from the local sensor and transmit the temperature value to the indoor unit every 3 minutes.

Technique certification and requirement

EMC should confirm the CE certification.

INSTALLATION

1 Safety precautions

Read the safety precautions carefully, stated below are important safety issues that must be obeyed

WARNING

- Please entrust the distributor or professionals to install the unit, do not install the unit by the user.
 - Do not uninstall the unit randomly.
 - The wiring should adapt to the wire controller current.
 - The specified cables shall be applied in the wiring. No external force may be applied to the terminal.
 - The circuit of wire controller is low voltage circuit, do not contact to the high voltage circuit and can not be arranged in the same wiring pipe with the high circuit, the distance between the wiring pipes should at least more than 300-500 mm.
 - Do not connect transition or extended connection in the middle of the wirings of the wire controller.
-

2 INSTALLATION ACCESSORIES

Please confirm that all the following parts you have been supply.

Number	Name	Qty	Remark
1	Wire controller	1	—
2	M4×25 cruciform slot screw	2	This accessory is used when install the wire control inside the electric cabinet
3	Installation and operation manual	1	—
4	Plastic bolt	2	This accessory is used when install the wire control inside the electric cabinet
5	The connective wires of signal received panel	1	For connect between the signal received wire and shielded 5-core cable

Please filed install the following accessory.

Number	Name	Qty.	Remark
1	Install box	1	Universal electric cabinet specification, pre-embed it into wall.
2	Shielded 5-core cable	1	Pre-embed RVVP- 0,5mm 2x5 into wall
3	Wire configured tube (insulated sheath)	1	Pre-embed into wall, the longest length should not exceeding than 15 m.
4	Philips screwdriver	1	For install Cruciform slot screw.
5	Slotted head screwdriver	1	For unscrew the bottom cover of wire controller.

3 Installation methods

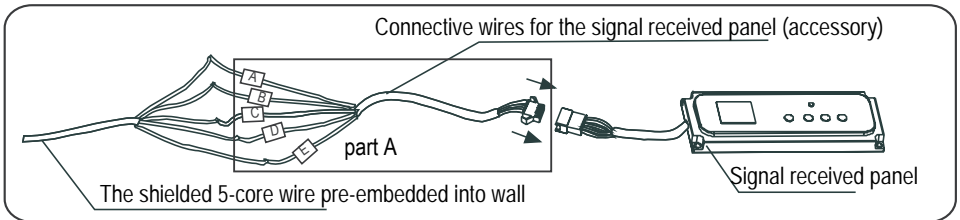

- 1) Cut off the connective wires for the signal received panel (accessory) from the middle (no protecting sleeve part), divide to be A, B parts and the A part has big 5-core connector as well as B part small 5-core connector.
- 2) Connect the big 5-core connector of the A part signal received panel connecting wire group with the 5-core terminal of signal received panel, refers to the above.
- 3) Please connect the other side (cut-off side) of A part signal received panel with the wall pre-bedded 5-core cable reliability, refers to the above.

- 4) Please connect the cut-off side of B part signal received panel with the wall pre-bedded 5-core cable reliability, refers to the right.

Connecting wires of two sides in digital display pipe must be connected one to one.

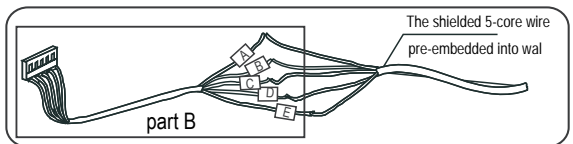

- 5) Insert to the bottom cover to the electric cabinet by the accessory slotted head screws and take down the bottom cover of wire controller refers to the right.

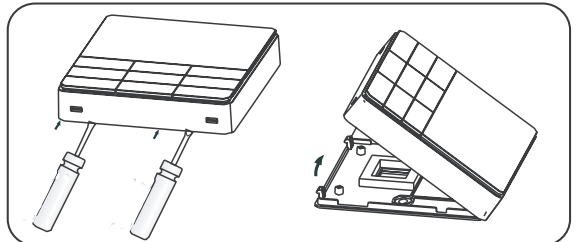

- 6) Adjust the length of two plastic bolts base on the length of through

out from standard electric cabinet to the wall. Confirm the two bolts fixing in the cabinet are in the same length and vertical to the wall surface.

- 7) Make the connecting wires of B part signal receiving panel to go through the hole of back cover and use.

Make sure the back cover of wire controller in the same level refers to the below.

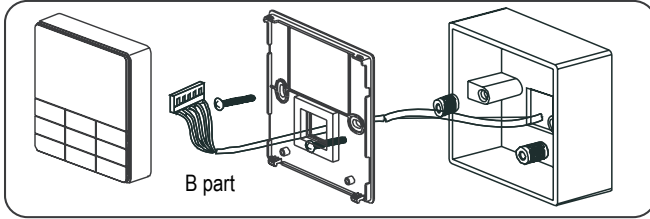

- 8) Insert the small 5-core connector of the B part signal receiving panel connecting wire group with the 5-core terminal of wire controller PCB panel one to one and then cover the wire controller with the back cover refers to the below.

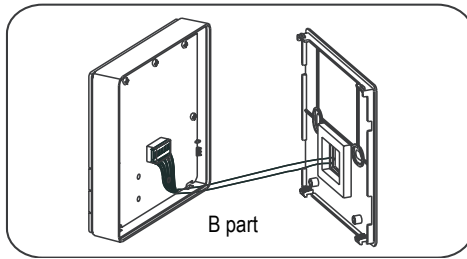

- Overtighten the screw would cause rear cover deformed and LCD damage.
- When installation, please maintain the screws and wire controller at the same height level without deformed.
- When installation, please reserve a certain length of wire controller connective cable for future maintenance to take off the wire controller.

4 WIRING DIAGRAMS WITH AIR CONDITIONING INDOOR UNITS

Wiring diagram of the wire controller and the air conditioning indoor unit

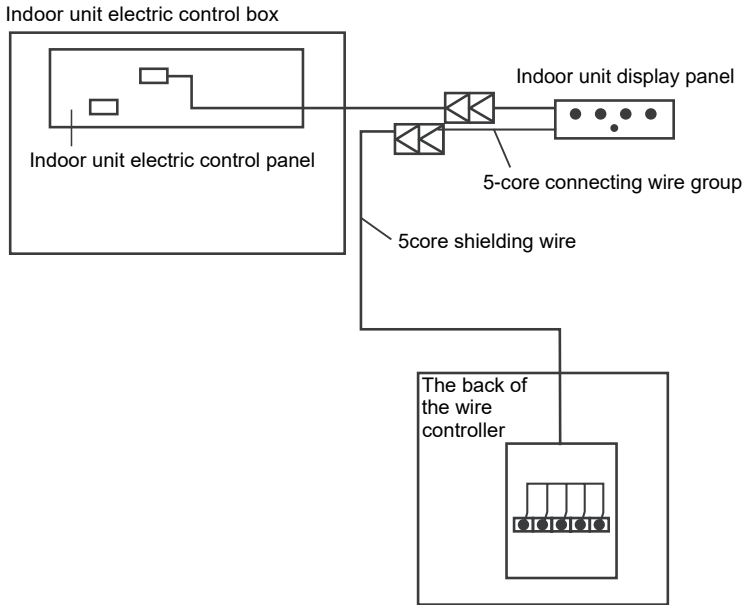

NOTE CONCERNING PROTECTION OF ENVIRONMENT



This product must not be disposed of via normal household waste after its service life, but must be taken to a collection station for the recycling of electrical and electronic devices. The symbol on the product, the operating instructions or the packaging indicate such disposal procedures. The materials are recyclable in accordance with their respective symbols. By means of re-use, material recycling or any other form of recycling old appliances you are making an important contribution to the protection of our environment. Please ask your local council where your nearest disposal station is located.

PRODUCER

SINCLAIR CORPORATION Ltd.
1-4 Argyll St.
London W1F 7LD
United Kingdom

www.sinclair-world.com

This product was manufactured in China (Made in China).

REPRESENTATIVE

SINCLAIR Global Group s.r.o.
Purkynova 45
612 00 Brno
Czech Republic

TECHNICAL SUPPORT

SINCLAIR Global Group s.r.o.
Purkynova 45
612 00 Brno
Czech Republic

Tel.: +420 800 100 285
Fax: +420 541 590 124

www.sinclair-solutions.com
info@sinclair-solutions.com

