



„ORIGINAL INSTRUCTIONS“

IMPORTANT NOTE:

Read this manual carefully before installing or operating your new air conditioning unit. Make sure to save this manual for future reference.

EN

For downloading manual for this product, please enter the model name at this link:

**CZ**

Pro stažení manuálu k tomuto produktu zadejte modelové označení do následujícího odkazu:

**SK**

Pre stiahnutie manuálu k tomuto produktu zadajte modelové označenie do nasledujúceho odkazu:

**DE**

Um das Handbuch für dieses Produkt herunterzuladen, geben Sie bitte den Modellnamen für diesen Link ein:

**HR**

Za preuzimanje priručnika za ovaj proizvod unesite naziv modela na ovu vezu:

**HU**

Termék kézikönyvének letöltéséhez írja be a modell megnevezését az alábbi linkre:

**SL**

Za prenos navodil za uporabo tega izdelka, vnesite ime modela na tej povezavi:

**RU**

Чтобы загрузить руководство для этого продукта, введите обозначение модели по следующей ссылке:

**IT**

Per scaricare il manuale di questo prodotto, inserisci il nome del modello a questo link:

**ES**

Para descargar el manual de este producto, ingrese la designación del modelo en el siguiente enlace:



SAFETY INSTRUCTIONS

IMPORTANT!

AIR CONDITIONERS MUST ALWAYS BE STORED AND TRANSPORTED UPRIGHT, OTHERWISE IRREPARABLE DAMAGE MAY BE CAUSED TO THE COMPRESSOR; IF IN DOUBT WE SUGGEST WAITING AT LEAST 24 HOURS FOLLOWING INSTALLTION BEFORE STARTING THE UNIT.



- Carefully read the instructions before installing and/or operating the unit.
- This appliance is for indoor use only.
- This unit must be only connected to a 220-240 V / 50 Hz earthed outlet.
- Installation must be in accordance with regulations of the country where the unit is used.
- If you are in any doubt about the suitability of your electrical supply have it checked and, if necessary, modified by a qualified electrician.
- This air conditioner has been tested and is safe to use. However, as with any electrical appliance - use it with care.
- Disconnect the power from the appliance before dismantling, assembling or cleaning.
- Avoid touching any moving parts of the appliance.
- Never insert fingers, pencils or any other objects though the guard.
- This appliance is not intended for use by persons (including children) with reduced physical, sensory or mental capabilities. It is also not intended for use by those with a lack of experience and knowledge, unless they have been given supervision or instruction concerning the use of the appliance by a person responsible for their safety.
- Do not leave children unsupervised with this appliance.
- Do not clean the unit by spraying it or immersing it in water.
- Never connect the unit to an electrical outlet using an extension cord. If an outlet is not available, one should be installed by a qualified electrician.
- Do not operate the unit unless it has been fully installed following the guidance provided within this manual.
- Never operate this appliance if the cord or plug is damaged. Ensure the power cord is not stretched or exposed to sharp objects/edges.
- A damaged supply cord should be replaced by the manufacturer or a qualified electrician in order to avoid a hazard.
- Any service other than regular cleaning or filter replacement should be performed by an authorised service representative. Failure to comply could result in a voided warranty.
- Do not use the appliance for any purpose other than its intended use.
- Avoid restarting the air conditioner unless 3 minutes have passed since being turned off. This prevents damage to the compressor.
- Never use the mains plug as a switch to start and turn off the air conditioner. Use the provided ON/OFF button located on the control panel.
- The appliance should not be installed in laundry or wet rooms.
- The appliance must be installed in a room without sources of ignition (for example: open flames, an operating gas appliance or an operating electric heater).
- The unit must be installed on a solid vertical wall by a competent person. The electricity supply must only be connected after installation is complete.
- R290 refrigerant gas complies with European environmental directives.

- R290 has a low GWP (Global Warming Potential) of 3.
- The air conditioner contains about **290g** of R290 refrigerant gas.
- Do not install or store in an unventilated space with an area smaller than **15 m²** per unit. The room must be such as to prevent stagnation of possible leaks of refrigerant gas as there could be a danger of fire or explosion hazard should the refrigerant come into contact with electric heaters, stoves or other sources of ignition.
- If the appliance is installed, used or stored in an unventilated room, the room must be such as to prevent stagnation of possible leaks of refrigerant gas as there could be a danger of fire or explosion should the refrigerant come into contact with electric heaters, stoves or other sources of ignition.
- Refrigerant gas may be odourless.
- Do not use the product and contact the retailer for advice, if damage has occurred to the unit which may have compromised the refrigerant system.
- Any repairs or maintenance must only be carried out on the unit by a suitably qualified engineer. Before opening and servicing the unit the authorized engineer must be in possession of a copy of the manufacturer's service manual and must follow the safety information contained within it to ensure all hazards are minimized.
- The refrigerant system should not be perforated or punctured.

Energy Saving and Unit Safety Protection Tips

- Do not cover or restrict the airflow from the outlet or inlet grills.
- Keep the filters clean . Under normal conditions , filters should only need cleaning once every three weeks (approximately) . Since the filters remove airborne particles , more frequent cleaning maybe necessary , depending on the air quality.
- For the initial start-up set the fan speed to maximum and the thermostat to 4-5 degree lower than the current temperature . After , set the fan switch to low and set the thermostat to your desired setting.
- To protect the unit , we recommend not using the cool mode when the ambient temperature is higher than 35°C.

NOTE : Some pictures and information may vary from the final product . This is due to continual product improvement.

PRODUCT OVERVIEW

PRODUCT DIAGRAM

FRONT

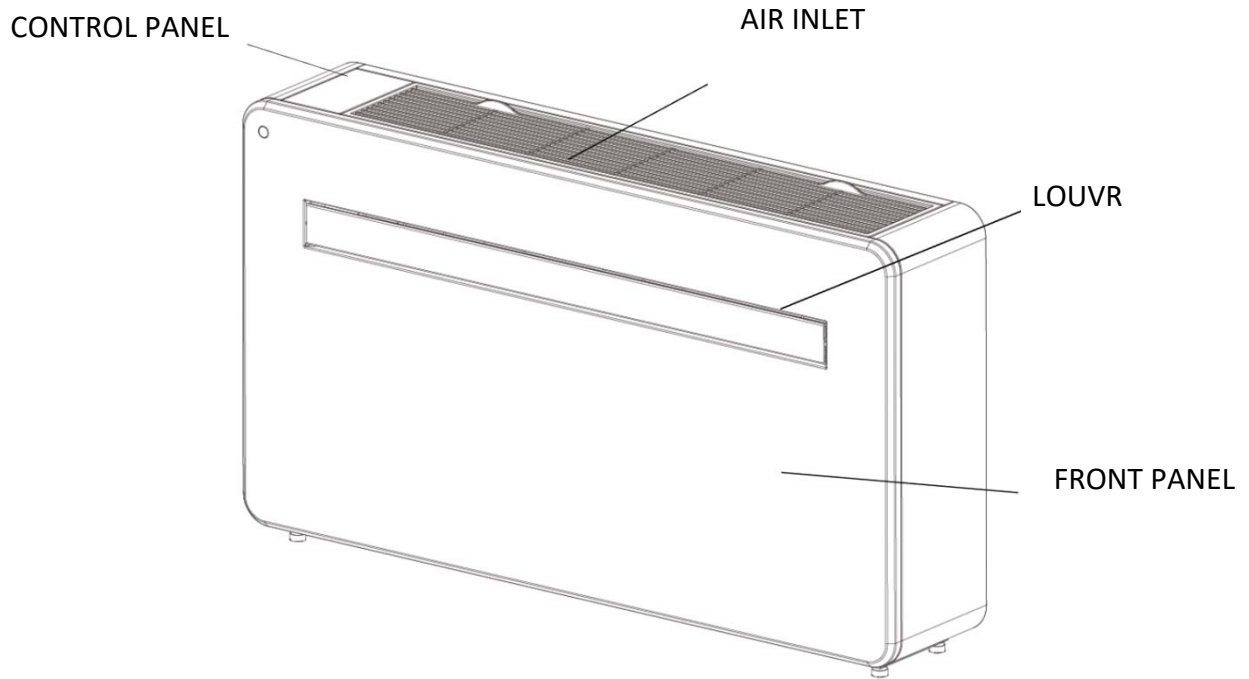

BACK

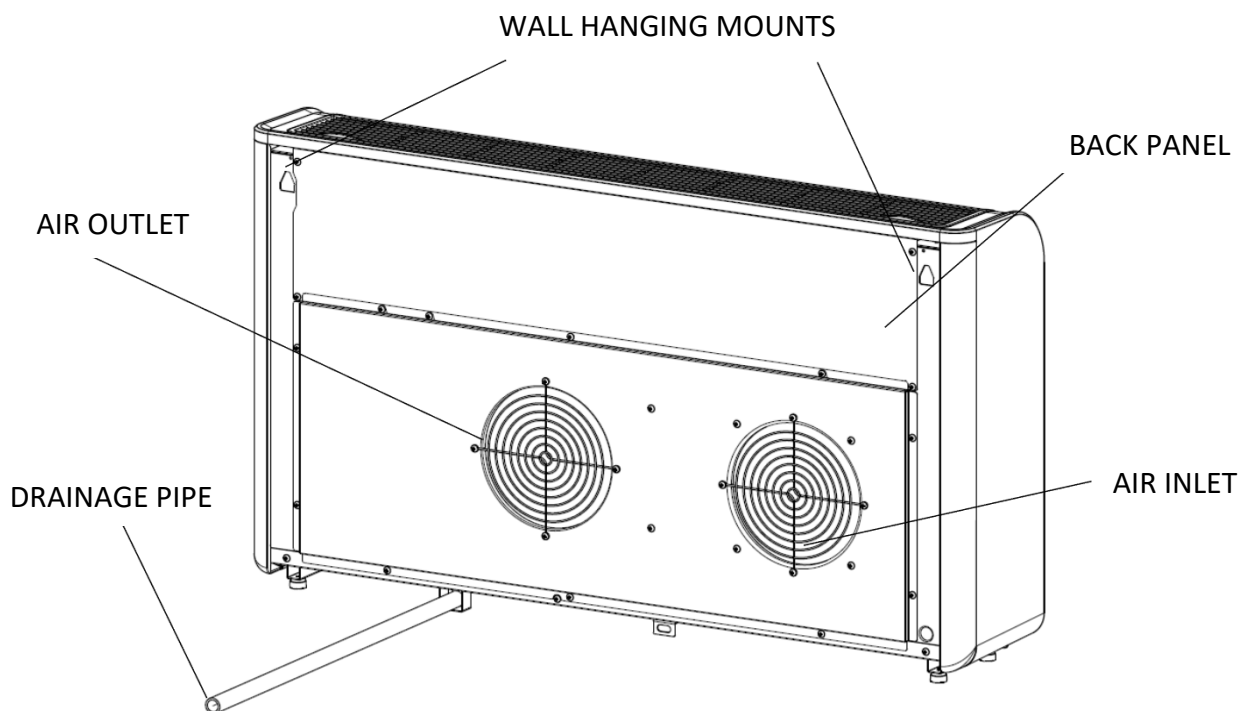

FEATURES

- ◆ Simple operation.
- ◆ Self-evaporative function with energy saving technology.
- ◆ Sleek design that seamlessly fits into any style home.
- ◆ Bright LED screen-indicates temperature and current mode.
- ◆ On / off timer function-allows you to choose when the unit operates.
- ◆ WIFI App control providing additional functionality.
- ◆ Three fan speeds.
- ◆ Four modes to suit your every need including : Cooling / Heating / Fan / Dry
- ◆ Silent running option , perfect for a restful night sleep.

WHATS INCLUDED

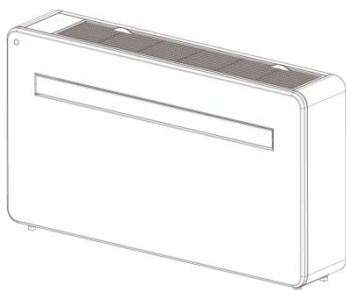

AIR CONDITIONER

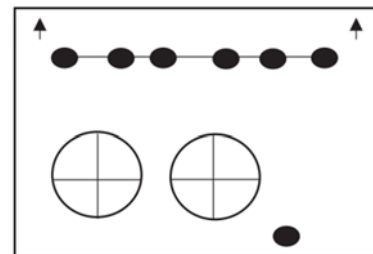

WALL TEMPLATE

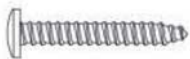

7PCS SCREWS (5×60mm)



7PCS WALL PLUGS (8×40mm)



**VENT COVER ASSEMBLY (X2)
(CHAIN, INDOOR RING AND
OUTDOOR COVER)**

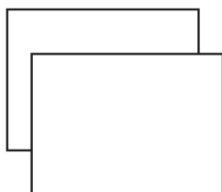

**PLASTIC DUCTING
SHEET (X2)**



WALL BRACKET



REMOTE CONTROL



FIXED PLATE

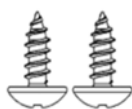

**2PCS TAPPING SCRE
(4x10mm)**

DIAGRAMS FOR ILLUSTRATIVE PURPOSES ONLY

INSTALLATION

TOOLS REQUIRED

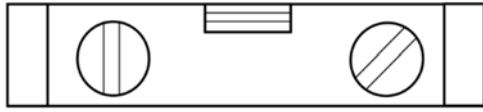

SPIRIT LEVEL

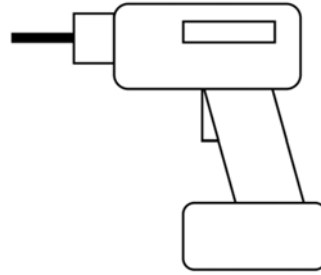

DRILL

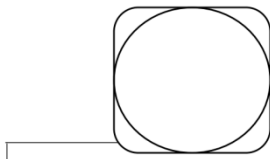

TAPE MEASURE

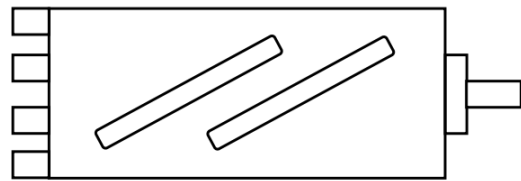

180mm CORE DRILL



8mm MASONRY DRILL



SHARP KNIFE



20mm MASONRY DRILL BIT

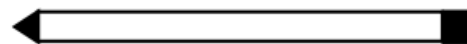

PENCI

BEFORE STARTING INSTALLATION, PLEASE ENSURE YOU HAVE ALL SUITABLE EQUIPMENT AVAILABLE AND UNDERSTAND THE STEPS INVOLVED IN INSTALLATION. IF IN ANY DOUBT, PROFESSIONAL ADVICE SHOULD BE SOUGHT.

THE INSTALLER MUST ENSURE THAT THE PLANNED POSITION OF THE AIR CONDITIONER IS SUITABLE, AND THAT THERE ARE NO CABLES AND PIPES INSIDE THE WALL, AND NO OTHER OBSTRUCTIONS FOXED ON THE WALL, WHICH WOULD PRESENT A DANGER AND/OR PREVENT COMPLETION OF INSTALLATION.

INSTALLATION

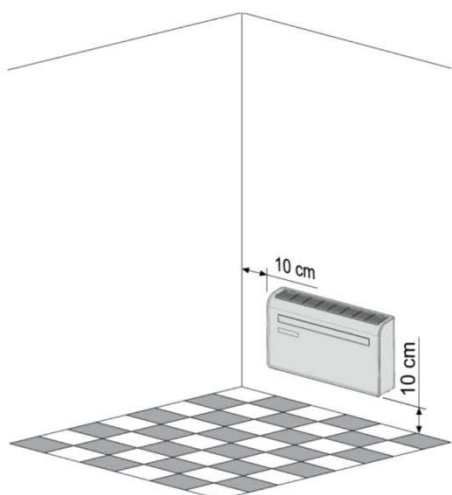

This unit must be installed on an external wall, as it vents directly out of its rear, and ensure the wall is flat, solid and reliable.

Leave at least 10 cm of space to the left, right and base of the machine. At least 20cm of space must be left above the unit to help air flow smoothly and stay away from curtains, plants, faucets, furniture and others appliances etc.

Paste the supplied installation template paper in position on the wall, ensuring that the reference line is level using a spirit level.

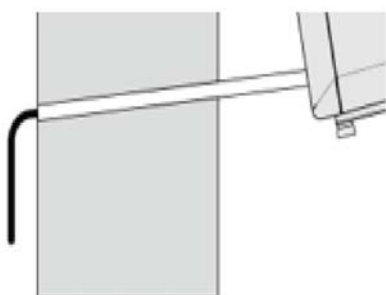
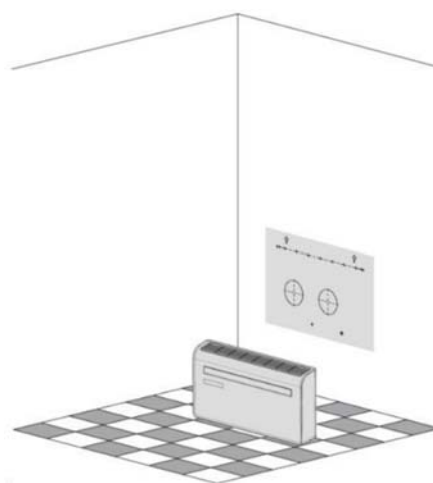

The hole for the drainage pipe must be drilled using a 20mm Drill bit. Ensure the hole is at a downward angle (min 5 degrees) so that the water will drain correctly.

Use a 180mm core drill to drill the two holes for the units ventilation, ensuring that both the holes are aligned with the template.

Use the template to mark the position of the screws for the hanging rail, using a spirit level to ensure it is straight and level. Drill the marked holes using a suitable 8mm drill bit and insert wall plugs. Line the hanging rail with the holes, and fix the rail into position using the supplied screws.

Ensure that the hanging rail is securely fastened onto the wall, and that there is no risk of the unit tipping or falling.

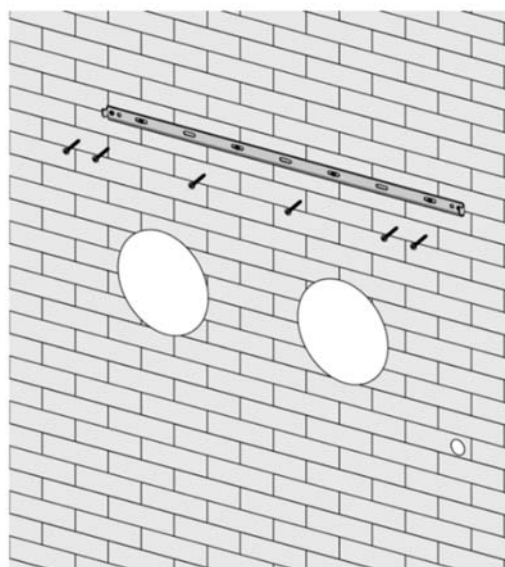

Roll the plastic vent sheets into a tube and feed them from the inside into the holes previously made. Ensure the tubes sit flush to the interior wall.

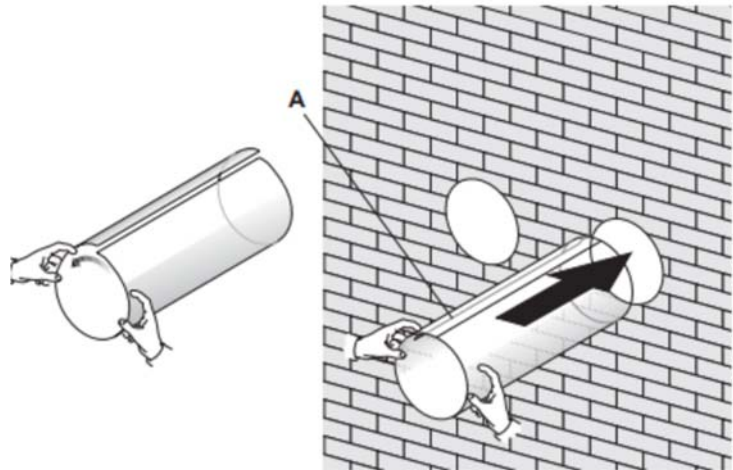
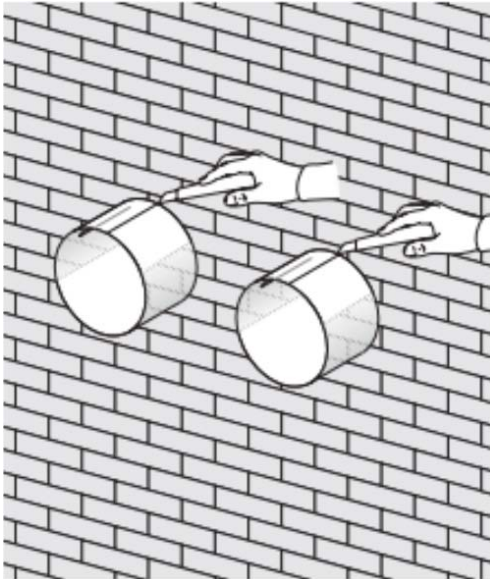

Go outside and trim off the excess vent tube using a sharp knife, keeping the edge as neat as possible.

Insert the indoor fixing ring from the vent cover onto the indoor side of the air vent. Then fold the external vent cover in half. Attach the chains to each side of the vent cover, before sliding the cover outside through the vent hole.

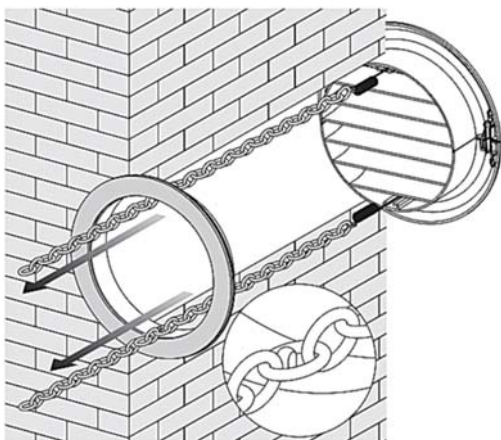
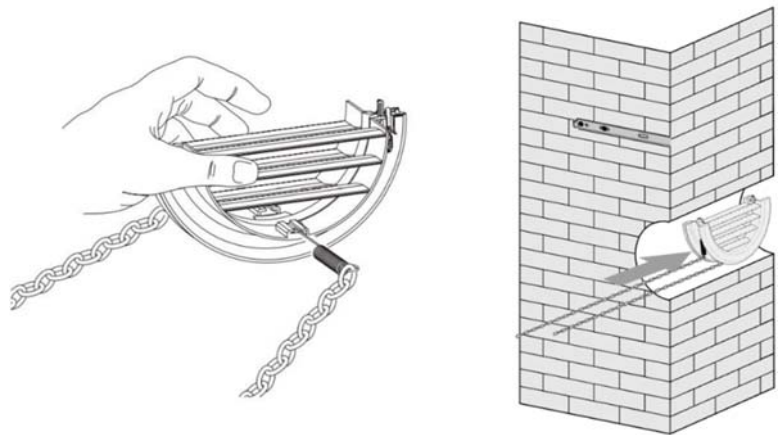

Expand the external cover, before tightly fixing the chains by hooking onto the indoor fixing ring. This will hold the external cover firmly in position. Repeat for the second vent.

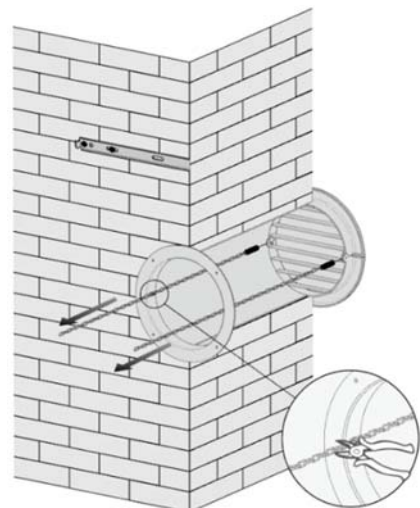

Once the chains are fitted and secure, any excess chain should be removed by cutting the chain.

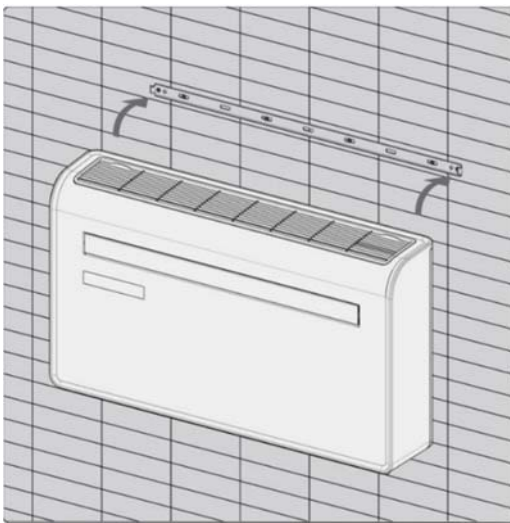

Lift the unit onto the wall, align the hanging holes with the hooks on the hanging rail and gently rest the unit into place. At the same time, slide the drain pipe through the drainage hole.

NOTE:

1st: please ensure that the backside of product is tightly attached on the wall to avoid additional vibration and noise.

2nd: The end of the external water pipe must be placed in an open space or drain. Avoid damage or constriction to the drainage pipe to ensure the unit drains.

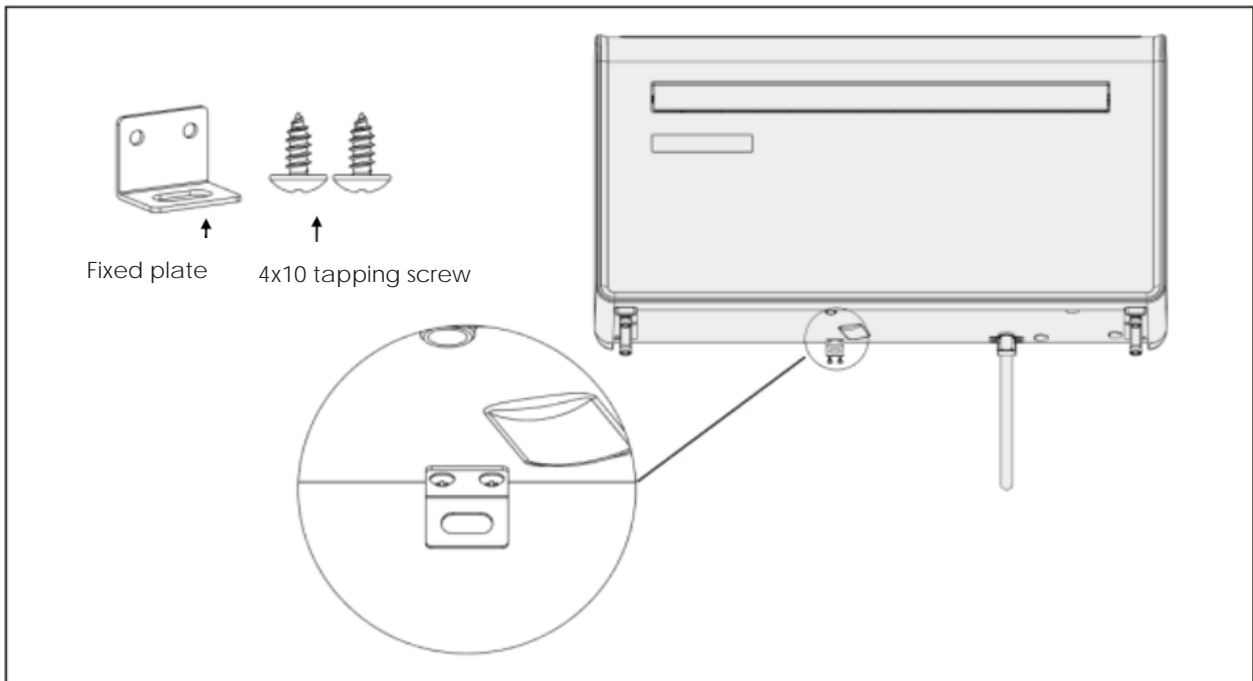

OPERATION

CONTROL PANEL

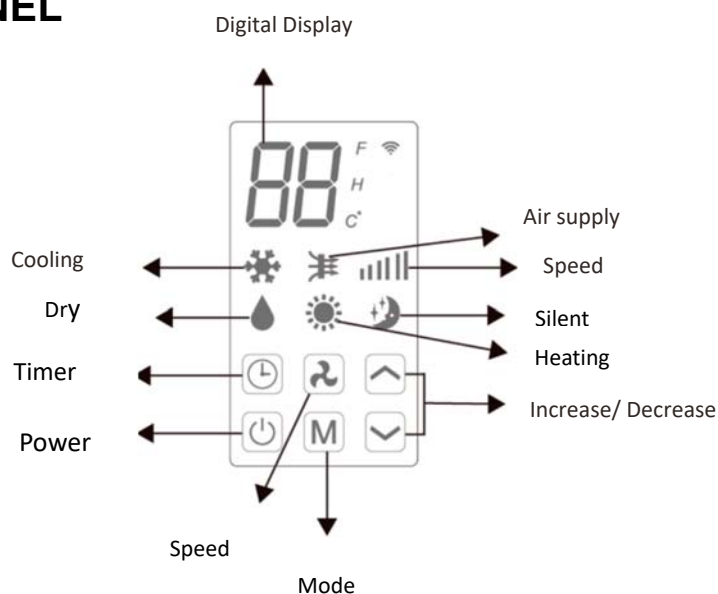











REMOTE CONTROL

The air conditioner can be controlled with the remote control. Two AAA-batteries are required.

NOTE: Further details of the functions can be found on the following page.

POWER	Press the POWER button to turn the machine on or off.	
MODE	Press the MODE button to switch between cooling, heating, fan and dry modes.	
FAN	Press the FAN button to change between high, medium and low fan speeds	
LED	Press the LED button to open or close the LED background light of unit, it can be a choice for sleep condition.	
	Press the UP button to increase the desired temperature or timer duration	
	Press the DOWN button to decrease the desired temperature or timer duration	
SILENT	Press it for silent mode, In Silent mode, noise will be lower, fan works in low speed, frequency is low.	
SWING	Press to turn the louver swing function on and off (only activated by the remote control & APP)	
TIMER	Press the TIMER button to set the automatic switch on/off.	

FUNCTIONS

 POWER	Press "POWER" to turn the unit On or Off.	
 MODE	Press to change between the 4 different modes. The display will show the symbol for the mode currently selected.	
	 COOLING	The cooling function allows the air conditioner to cool the room and at the same time reduces air humidity. The desired temperature can be adjusted using the increase and decrease button between 16°C and 30°C. The fan speed can also be adjusted using the speed button.
	 DRY	Dry mode will extract moisture from the air, which will be drained outside using the installed drain pipe. the fan speed and the desired temperature cannot be adjusted in dry mode.
	 FAN	In fan mode the appliance will recirculate the air within the room, and will not cool, heat or dehumidify. The fan speed can be adjusted using the Speed button, But the desired temperature can not be set.
	 HEATING	The heating function allows the air conditioner to heat the room. The desired temperature can be adjusted using the increase and decrease button between 16°C and 30°C. The fan speed can also be adjusted using the speed button.
	 SILENT	Silent mode can be activated from APP or the remote control, It can also be activated by pressing "⏸" + "⏮" on unit control panel at the same time. It will only operate in cooling or heating modes, the fan speed will change to low and noise will be lower.
 FAN SPEED		Press to change the fan speed between Low, Medium and High. The fan speed cannot be adjusted in Dry or Silent modes.
 TIMER	The air conditioner contains a 24 hour timer, which can be used to either set a delayed start, or a set period of operation.	
	SHUTDOWN TIMER:	While the unit is running press the timer button, the display will flash "0" 5 times. After the 5th flash, use the up and down buttons to adjust the duration in 1 hour increments between 1 to 24 hours. When the timer has elapsed, the unit will shutdown automatically.
DELAYED START TIMER:	With the unit in standby, press the timer button, the display will flash "0" 5 times. After the 5th flash, use the up and down buttons to adjust the duration in 1 hour increments between 1 to 24 hours. After the timer has elapsed, the unit will start up in the same mode with the same settings as when it was turned off.	
 INCREASE AND DECREASE	Used within cooling and heating modes to adjust the desired temperature 16-30°C. Also used while setting the timer to adjust the duration.	
SWING MODE	After machine turns on, press the "SWING" button, louver will swing continuously up and down; by pressing the button again the movement will stop and the louver remain in that position. Swing mode can only be adjusted from the remote, and will initially be turned on by default. the louver will close automatic once switch OFF the product.	

COMPRESSOR PROTECTION	There is a 3 minutes delay on power on. In order to protect the life of the compressor and electronic components please do not switch on the unit for at least 5 minutes after you turned the unit off.
------------------------------	---

WIFI SETUP AND SMART FEATURES

WIFI SETUP

BEFORE YOU START

- Ensure your router provides a standard 2.4ghz connection.
- If your router is dual band ensure that both networks have different network names (SSID). The provider of your router / Internet service provider will be able to provide advice specific to your router.
- Place the air conditioner as close as possible to the router during setup.
- Once the app has been installed on your phone, turn off the data connection, and ensure your phone is connected to your router via WIFI.

DOWNLOAD THE APP TO YOUR PHONE

Download the "SMART LIFE" app, from your chosen app store, using the QR codes below, or by searching for the app in your chosen store.



CONNECTION METHODS AVAILABLE FOR SETUP

The air conditioner has two different setup modes, Quick Connection and AP connection (Access Point). The quick connection is a quick and simple way to set the unit up. The AP connection uses a direct local WIFI connection between your phone and the air conditioner to upload the network details.

In Standby mode press and hold the speed button for 3 seconds (until you hear a bleep) to enter the wifi connection mode.

Please ensure your device is in the correct wifi connection mode for the connection type you are attempting, the flashing of the wifi light on your air conditioner will indicate this.

Connection Type	Frequency of Flashes
Quick Connection	Flashes twice per second
AP Connection (Access Point)	Flashes once per three seconds

CHANGING BETWEEN CONNECTION TYPES

To change the unit between the two wifi connection modes, hold the Speed button for 3 seconds.

REGISTER THE APP

1. Press on the register button at the bottom of the screen.

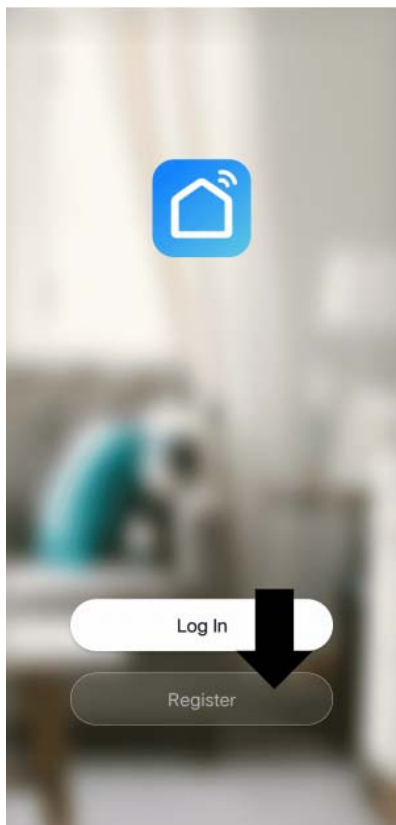

2. Read the Privacy policy and press the Agree Button.

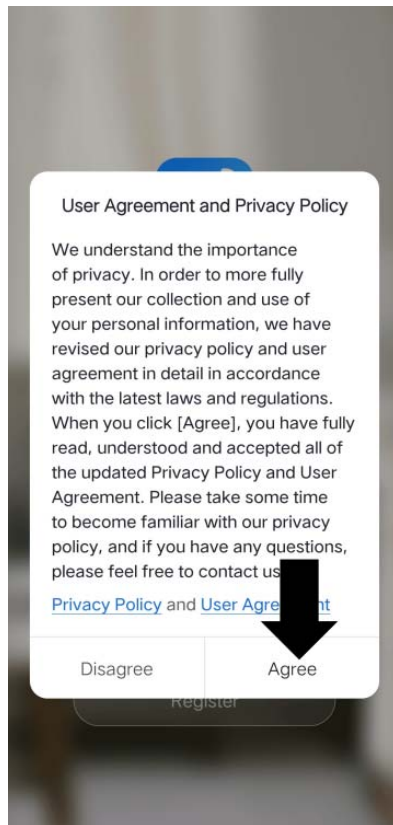

3. Enter your email address or phone number and press continue to register.

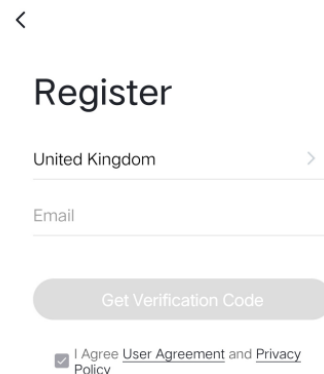

4. A verification code will be sent by the method selected in step 3. Enter the code into the app.

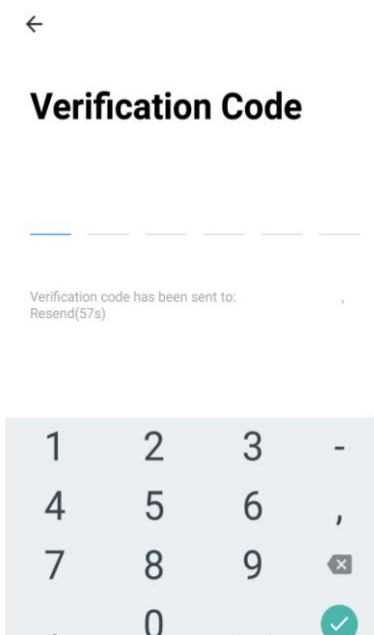

5. Type in the password you would like to create. This needs to be 6-20 characters, with letters and numbers.

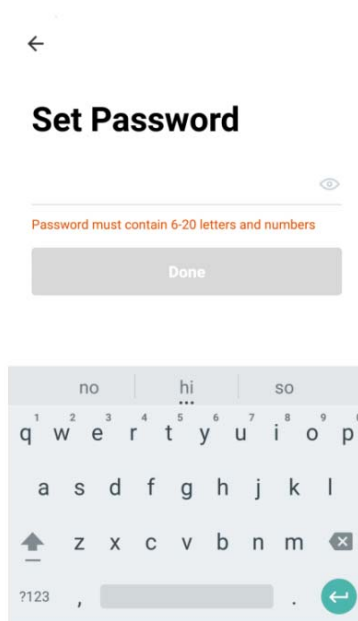

6. The app is now registered. It will automatically log you in following registration.

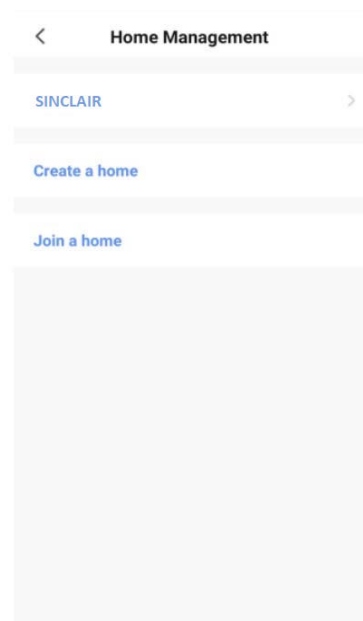

SETTING UP YOUR HOME WITHIN THE APP

SMART LIFE is designed so it can work with a large number of compatible smart devices within your home . It can also be set up to work with multiple devices within different houses As such during the setup process , the app requires that different areas are created and named to allow easy management of all your devices . When new devices are added , they are assigned to one of the rooms you have created.

CREATING ROOMS

1. Press on the create a home button.

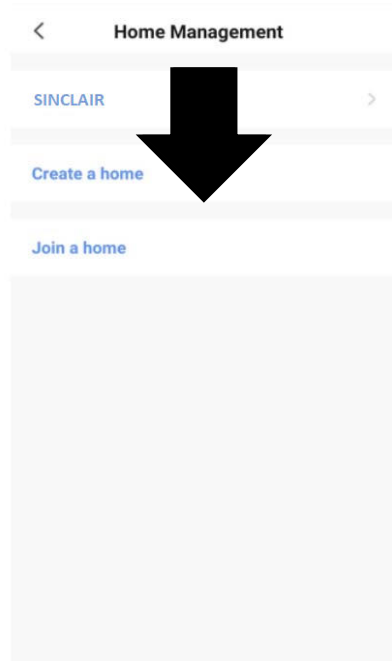

2. Type in a name for your home.

3. Press “home location” button to select the location of your home. (See SETTING YOUR LOCATION below)

4. New rooms can be added by pressing the ADD ROOM option at the bottom. (See ADD ANOTHER ROOM below). And untick any rooms that are not required on the app, then Press SAVE in the top right corner.

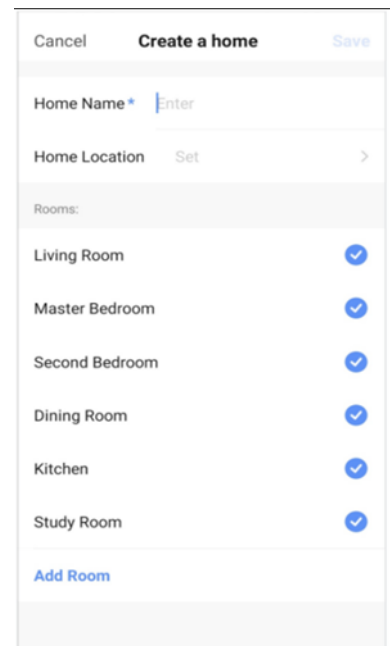

SETTING YOUR LOCATION

Use your finger to move the orange HOME symbol.

When the symbol is in the approximate location of your home, press the confirm button in the top right corner.

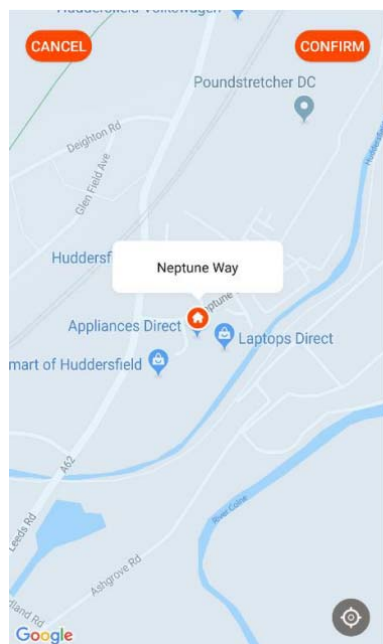

ADD ANOTHER ROOM

Type in the name of the room, and press Done in the top right corner.

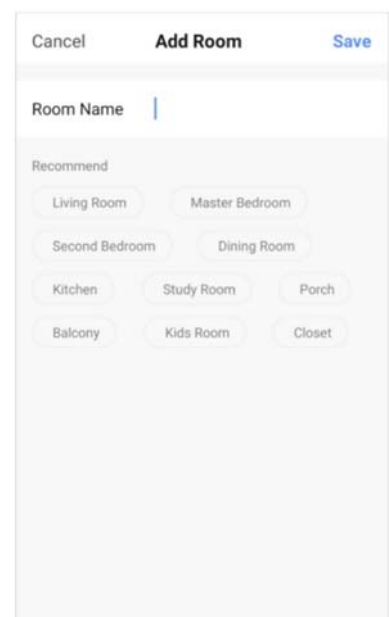

CONNECTING USING QUICK CONNECTION

Before initiating the connection, make sure the unit is in standby mode, with the WIFI light flashing twice per second. If not follow the instructions for changing the connection mode. Also ensure your phone is connected to the wifi network. (We advise turning mobile data off during setup)

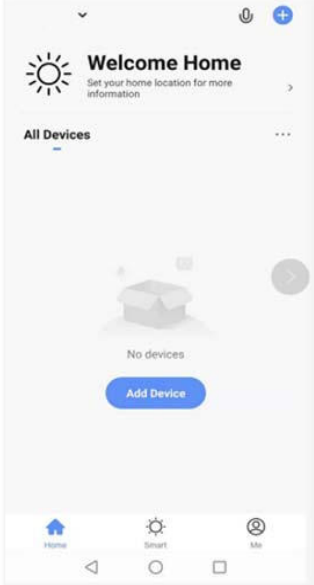
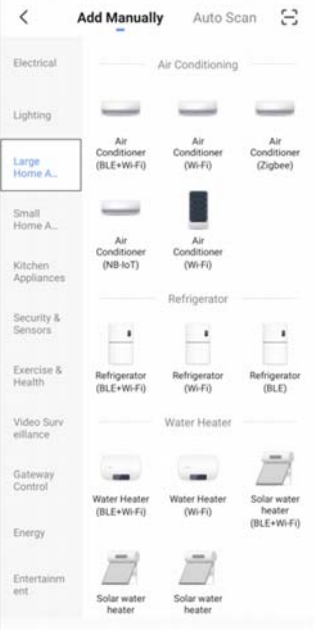
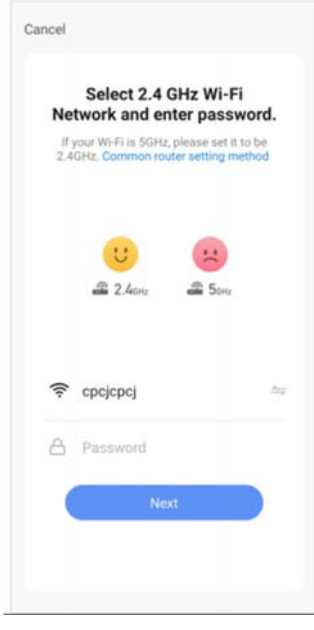
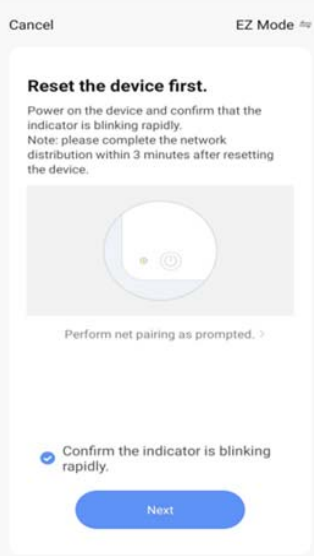
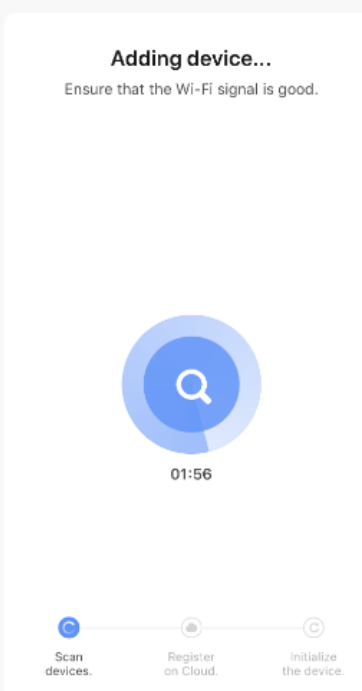
<p>1. Open app and press “+” to add device, or use the add device button.</p> 	<p>2. Select the type of device as “Large Home Appliance”</p> 	<p>3. Connect a WIFI and enter the password.</p> 
<p>4. Ensure the WIFI light on the air conditioner is flashing twice per second, then click NEXT button to enter the next setting.</p> 	<p>5. Click NEXT button to scan and connect a new device. Waiting for this process to complete.</p> <p>6. Please retry if this fails. please review the troubleshooting section for further help if still unsuccessful</p>	<p>Adding device...</p> <p>Ensure that the Wi-Fi signal is good.</p> 

CONNECTING USING AP MODE (ALTERNATIVE METHOD)

Before initiating the connection, make sure the unit is in standby mode, with the wifi light flashing once per second. If not follow the instructions for changing the wifi connection mode. Also ensure your phone is connected to the wifi network. (We advise turning mobile data off during setup)

- 1) Open app and press “+” to add device, or use the add device button.

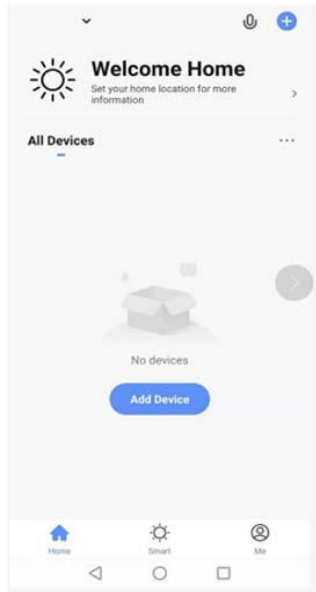

- 2) Select the type of device as “Large Home Appliance”

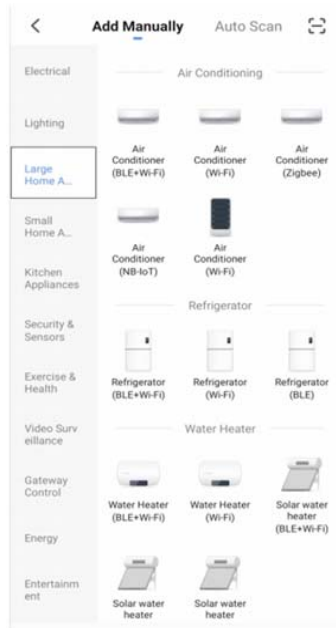

- 3) Enter your wifi password and press confirm.



- 4) Change to the AP mode in the top right of the screen.

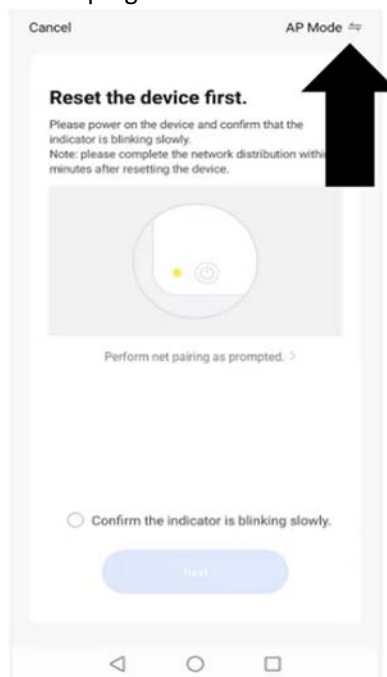

- 5) Ensure the wifi light on the air conditioner is slowly flashing (once per three seconds), then click NEXT button to enter the next setting.

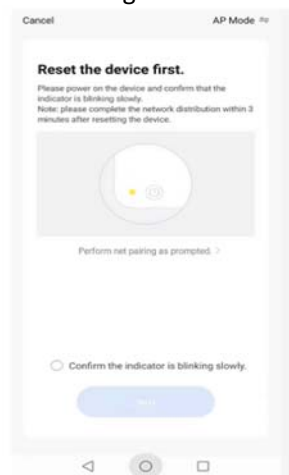

- 6) Get into network settings in your phone and connect to the “Smart Life xxx” connection. There is no password to enter. Then return back to the app to complete setup.



Once the connection process has completed, go back to the network settings on your phone to ensure your phone has reconnected to your WIFI router.

CONTROLLING YOUR DEVICE THROUGH THE APP

THE HOME SCREEN

Change Home: You can change between them if you created more than one home.

Environmental information: shown outdoor temperature and humidity based on the location details.

Smart Scene: Allows you to program intelligent behaviour based on the internal and external environment.

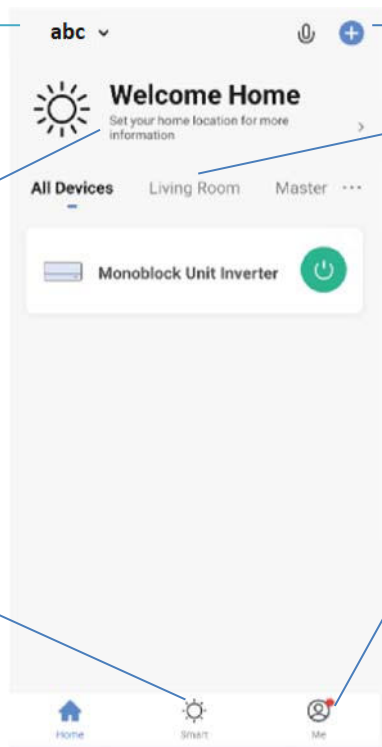

Add Device: Add new device on the APP, and go through the setup process.

Room Management: Use to view the units set up within each room. And Allows rooms to be added, removed or renamed.

Me: Provides the option for changing settings.

Each device has its own entry on the home screen to allow the user to either quickly turn the unit on or off, or to enter the device screen to make other changes.

DEVICE SCREEN

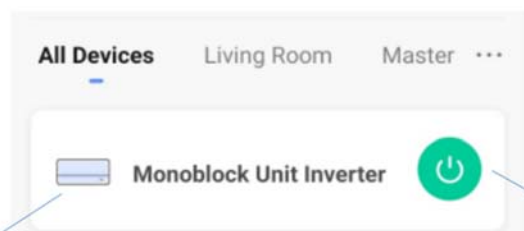

Name of Air Conditioner: Click to enter the Device Screen.

ON / OFF Button: Click to quickly turn on or off the device.

DEVICE SCREEN

The device screen is the main control screen for the air conditioner, providing access to the controls to amend the functions and settings.



***Due to continuous development of the app, the layout and available features may be subject to change.**

SMART SCENES

Smart Scenes is a powerful tool providing the option to customise the operation of the air conditioner based both on conditions within the room and outside influences. This gives the user the option of specifying much more intelligent actions. These are split into two categories Scene and Automation.

SCENE

Scene allows for a one touch button to be added to the Home screen. The button can be used to change a number of settings in one go, and can change all the settings within the unit. A number of scenes can easily be setup, allowing the user to easily change between a number of preset configurations.

Below is an example of how to set up a scene:

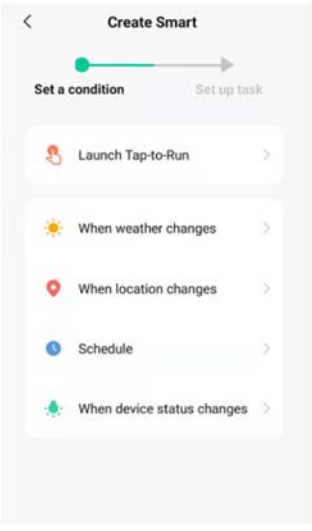
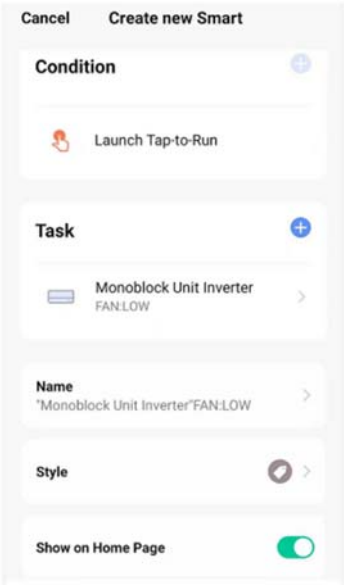
<p>1. Press on the Smart Scene tab at the bottom of the Home screen.</p> 	<p>2. Press on the Plus in the top right corner to add a smart scene.</p> 	<p>3. Press on the Launch Tap-to-Run to create a new Scene.</p> 
	<p>4. Press the arrow next to “Name” to input the name for your Scene</p> <p>Show on Home Page: Leave this on if you require the scene to be displayed as a button on the Home Screen</p> <p>Press the Blue Plus to add the action required. Then select the air conditioner from the list of devices.</p>	<p>5. Chose the function, set the value for the function, and then press the arrow button in the top left corner, to return to the previous screen.</p> 

6. Once all the functions required have been added, press the Save button in the top right corner to finalise and save your new Scene.

AUTOMATION

Automation allows an automatic action to be set up for the device. This can be triggered by the Time, indoor temperature, humidity of the room, weather conditions, and a range of other influences.

1. Press on the Smart Scene tab at the bottom of the Home screen.



2. Press on the Plus in the top right corner to add a smart scene.

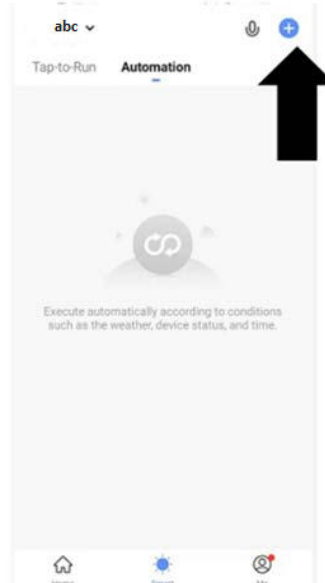

3. Press on the Launch Tap-to-Run to create a new Scene.

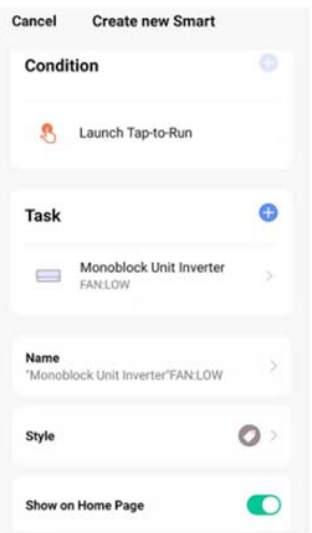
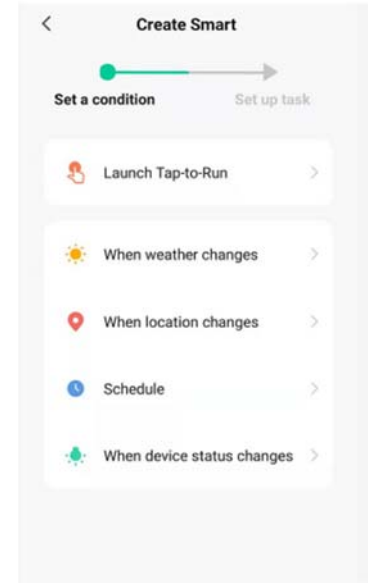

4. Setup is very similar to the scene setup on the previous page, and includes an extra section for specifying a trigger for the scene to start.
 Press the arrow next to "Name" to input the name for your Scene
 Show on Home Page: Leave this on if you require the scene to be displayed as a button on the Home Screen
 Press the Blue Plus to add the action required. Then select the air conditioner from the list of devices.

5. Chose the function, set the value for the function, and then press the arrow button in the top left corner, to return to the previous screen.

6. Chose the function, and then press the arrow button in the top left corner, to return to the previous screen.

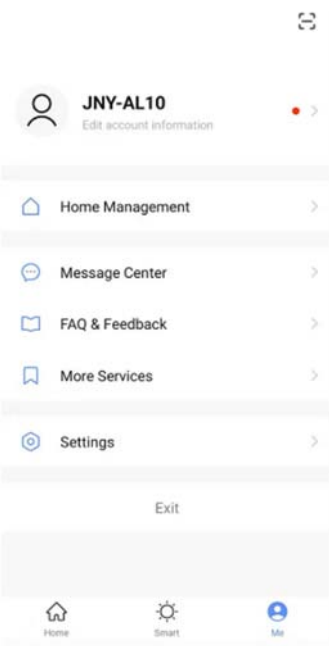
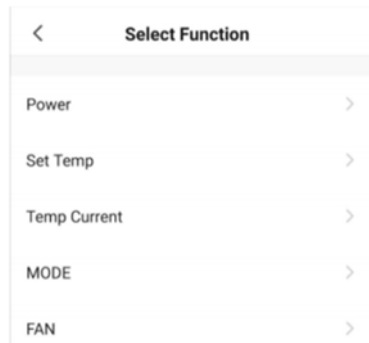

ME

The profile tab gives you the option to edit both your detail, and use the added features of the unit.

CHANGING THE NAME OF YOUR DEVICE

When in any of the device screens further settings for the device can be accessed, by pressing on the three dots in the top right hand corner. The top option within this allows you to change the name of the device to something relevant to the use of the product, such as “Living Room Air Conditioner”. Within the menu, you also have the option of setting up a pattern lock or change your password.

DEVICE SHARING

This allows you to share access to the controls of your air conditioner with friends and family.

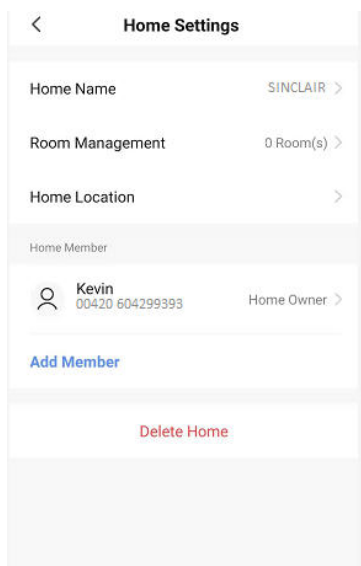

In page “Home Management”, select “My home”, you could “Add Member” there to share access to the controls of your air conditioner with friends and family, pls refer to the left picture.

INTEGRATION

This allows the unit to be integrated with your favourite home automation hardware such as Google Home and the Amazon Echo.

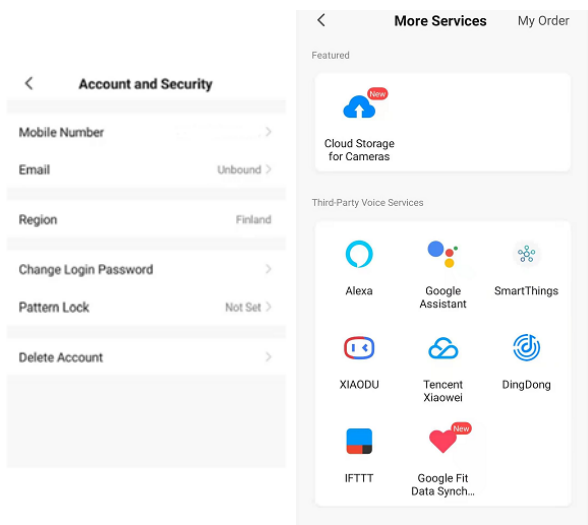

Select “More Services” , you could integrate with third-party voice services, pls refer to the left picture.

TROUBLESHOOTING

Do not repair or disassemble the air conditioning. Unqualified repair will invalidate the warranty and may lead to failure, causing injuries and property damage. Only use it as directed in this user manual and only perform operations advised here.

Problem	Reasons	Solutions
The air conditioner does not work	There is no electricity.	Check the unit is plugged in, and the socket is working normally.
	The ambient temperature is too low or too high.	Only use to use the machine with a room temperature between 7 and 35°C.
	In cooling mode, the room temperature is lower than the desired temperature; in heating mode, the room temperature is higher than the desired temperature.	Adjust the desired room temperature.
	In dehumidification (dry) mode, the ambient temperature is low.	Ensure that the room temperature is above 17°C for dry mode.
	There is direct sunlight.	Use curtains to reduce heat from the sun.
The cooling or heating effect is poor	Doors or windows are open; there are a lot of people; or in cooling mode, there are other sources of heat (e.g. fridges)	Close doors and windows; increase air conditioning power
	The filters screen is dirty.	Clean or replace the filter screen.
	The air inlet or outlet is blocked.	Clear obstructions; make sure the unit is installed as per the instructions
The air conditioner is leaking	The unit is not straight	Use a spirit level to check the unit is horizontal, if not remove from the wall and Straighten.
	The drain pipe is blocked	Check the drain pipe to ensure it is not blocked or constricted.
Compressor does not work.	Overheat protection operational .	Wait for 3 minutes until the temperature is lowered, and then restart the machine.

The remote control does not work.	The remote control is not aligned with the direction of the remote-control receiver.	Let the remote control get close to the air conditioner, and make sure that the remote control directly faces to the direction of the remote-control receiver.
	Batteries poor.	Replace batteries.

If problems not listed in the table occur or recommended solutions do not work, please contact the service centre.

ERROR CODES

Fault Code	Fault Description	Fault Code	Fault Description
F1	Compressor IPM error	P6	Coil tube overload protection
F2	PFC/IPM error	P7	Defrost protection on coil tube
F3	Compressor start error	P8	Zero-crossing fault detection
F4	Compressor running out of step	PA	Return air sensor temperature abnormal protection
F5	Location detection loop failure	PE	Abnormal refrigerant circulation
F6	PCB communication error	PH	Exhaust temperature protection
F8	Sensor on suction pipe error	E0	Sensor on suction pipe error
FA	Phase current overcurrent protection	E1	Temperature sensor error
FL	Water-full protection	E2	Sensor error on indoor coil tube
P1	Over-heat protection on top of compressor	E3	DC fan Feedback failure
P2	Dc bus voltage Undervoltage protection	E5	Water-splash motor error
P3	AC Input voltage protection	E8	Fan feedback fault
P4	AC over-current protection	EE	EE error
P5	AC undervoltage protection		

NOTE CONCERNING PROTECTION OF ENVIRONMENT



This product must not be disposed of via normal household waste after its service life, but must be taken to a collection station for the recycling of electrical and electronic devices. The symbol on the product, the operating instructions or the packaging indicate such disposal procedures. The materials are recyclable in accordance with their respective symbols. By means of re-use, material recycling or any other form of recycling old appliances you are making an important contribution to the protection of our environment. Please ask your local council where your nearest disposal station is located.

INFORMATION CONCERNING USED REFRIGERANT MEDIUM

The maintenance and the liquidation must be carried out by qualified personnel.

Type of refrigerant: R290

The quantity of the refrigerant: Please see the unit label.

The value GWP: 0

GWP = Global Warming Potential



Appliance filled with flammable gas R290.

In case of quality problem or other please contact your local supplier or authorized service center.

Emergency number: 112

PRODUCER

SINCLAIR CORPORATION Ltd.
1-4 Argyll St.
London W1F 7LD
Great Britain
www.sinclair-world.com

This product was manufactured in China (Made in China).

REPRESENTATIVE

SINCLAIR Global Group s.r.o.
Purkynova 45
612 00 Brno
Czech Republic

TECHNICAL SUPPORT

SINCLAIR Global Group s.r.o.
Purkynova 45
612 00 Brno
Czech Republic
Tel.: +420 800 100 285 | Fax: +420 541 590 124
www.sinclair-solutions.com | info@sinclair-solutions.com



