



FULL DC INVERTER SYSTEMS
USER & INSTALLATION MANUAL

SWC-62

COMMERCIAL AIR CONDITIONERS SDV6



INSTALLATION & OWNER'S MANUAL

Wired Controller



Thank you very much for purchasing our product.

Before using your unit, please read this manual carefully and keep it for future reference.

- This manual gives detailed description of the precautions that should be brought to your attention during operation.
- In order to ensure correct service of the wired controller please read this manual carefully before using the unit.
- For convenience of future reference, keep this manual after reading it.

CONTENTS

1 GENERAL SAFETY PRECAUTIONS

- 1.1 About the documentation 01
- 1.2 For the user..... 03

2 OPERATION

- 2.1 Wired controller: Overview 05
- 2.2 Operation..... 06
- 2.3 Troubleshooting 51
- 2.4 FQA..... 52

3 INSTALLATION

- 3.1 Precautions for Installation 55
 - 3.2 Basic Parameters 56
 - 3.3 Accessories 57
 - 3.4 Installation 58
 - 3.5 Engineering Menu 67
-

1 GENERAL SAFETY PRECAUTIONS

1.1 About the documentation

- The original documentation is written in English. All other languages are translations.
- The precautions described in this document cover very important topics, follow them carefully.
- All activities described in the installation manual must be performed by an authorized installer.

1.1.1 Meaning of warnings and symbols



DANGER

Indicates a situation that results in death or serious injury.



DANGER: RISK OF ELECTROCUTION

Indicates a situation that could result in electrocution.



DANGER: RISK OF BURNING

Indicates a situation that could result in burning because of extreme hot or cold temperatures.

WARNING

Indicates a situation that could result in death or serious injury.

CAUTION

Indicates a situation that could result in minor or moderate injury.

NOTE

Indicates a situation that could result in equipment or property damage.

INFORMATION

Indicates useful tips or additional information.

1.2 For the user

- If you are not sure how to operate the unit, contact your installer.
- The appliance is not intended for use by persons, including children, with reduced physical, sensory or mental capabilities, or lack of experience and knowledge, unless they have been given supervision or instruction concerning use of the appliance by a person responsible for their safety. Children must be supervised to ensure that they do not play with the product.



CAUTION

Do NOT rinse the unit. This may cause electric shocks or fire.



NOTE

- Do NOT place any objects or equipment on top of the unit.
- Do NOT sit, climb or stand on the unit.

- Units are marked with the following symbol:



This means that electrical and electronic products may not be mixed with unsorted household waste. Do not try to dismantle the system yourself: the dismantling of the system, treatment of the refrigerant, of oil and of other parts must be done by an authorized installer and must comply with applicable legislation. Units must be treated at a specialized treatment facility for reuse, recycling and recovery. By ensuring this product is disposed of correctly, you will help to prevent potential negative consequences for the environment and human health. For more information, contact your installer or local authority.

2 OPERATION



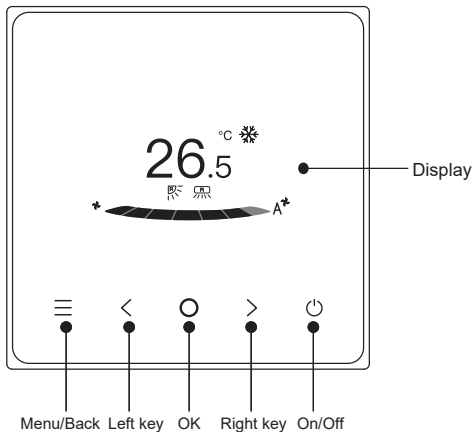





2.1 Wired controller: Overview





















2.2 Operation

- 1. On/Off** Press "⏻". The interface/operation button will light up and the device will start. Under one-to-many individual control, the screen will not die when the power-off button is pressed. Press "⏻" again. The screen/operation button will be off, and the device will shut down.
- 2. Menu/Back** Press "☰" to enter the menu selection screen. Press "☰" again to return to the main interface.
- 3. Left/Right key** Press "< " " > " to adjust the temperature and humidity.
- 4. Confirmation** Press "○" to wake up the screen.

Icon description

 Set temperature display	
 Timer off	 Timer on
 Cooling	 Heating
 Auto	 Dry
 Fan	 Indoor temp.

 Rapid cooling	 Rapid heating
 Up/down swing	 Left/right swing
 Sterilization	 Sleep
 Auxiliary heater	 ECO
 3D air	 Comfort
 Blow on people	 Avoid people
 ETA	 Backup Mode
 Mute IDU	 Lock child lock
 Fault prompt	 Unlock child lock
 Lock	

INFORMATION

Function icons will be displayed according to the IDU functions.

Mode

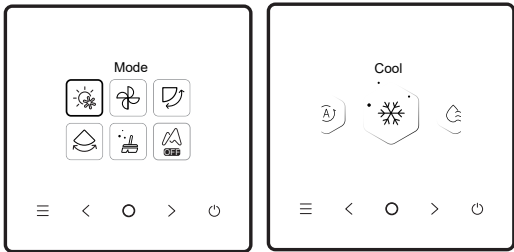

Select the mode on the menu and press "○" for confirmation. After entering the mode, press "<" or ">" to select the operating mode, and press "○" for confirmation. Or press "≡" to exit.

Mode conflict: When the system detects any mode conflict, the main screen of the wired controller will display a message indicating that no heating or cooling option is available.

CAUTION

All IDUs in the same air conditioning system can only operate in the same mode (such as cooling and heating). A conflict will occur if the IDUs operate in different modes. Therefore, make sure that the operating mode of all IDUs is the same.

Fan speed

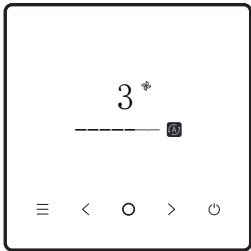
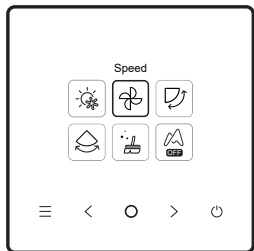

Select the fan speed on the menu, and press "○" for confirmation. After entering the fan speed interface, press "<" or ">" to select the operating speed, or press "≡" to return to the menu.



CAUTION

- Depending on IDU models, 3 speeds or 7 speeds are supported.
- With efficiency ensured, the air conditioner may adjust the fan speed depending on the indoor temperature, leading to a difference between the real-time fan speed and the set one or causing the fan to stop. This is normal.
- After the fan speed is set, it takes time for the air conditioner to respond. It is normal if the air conditioner does not respond to the setting immediately.

Swing

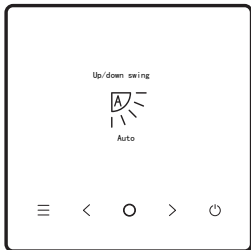
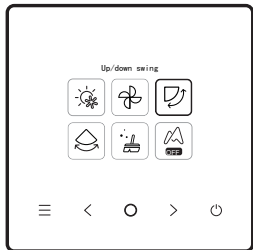

Select the swing (left/right) up/down function on the menu, and press "○" for confirmation. After entering the swing interface, press "<" or ">" to adjust the swing angle, or press "≡" to return to the menu.

CAUTION

- Some IDUs do not support the swing feature.
- When the unit is off, the wired controller automatically shuts louvers of the air outlet.

Independent swing only applies to IDUs with an independent swing device.

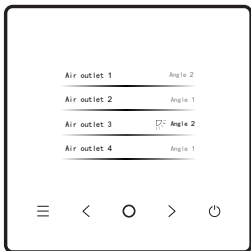
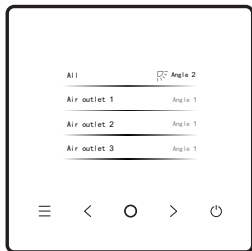

Select the swing up/down function on the menu, and press "○" for confirmation. After entering the swing interface, press "<" or ">" to select the air outlet to be controlled, or press "<" or ">" to adjust the swing angle.



CAUTION

- Independent swing only applies to IDUs with an independent swing device.

Timer & schedule

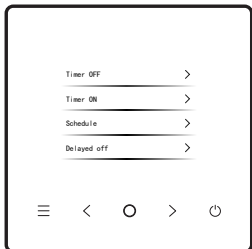
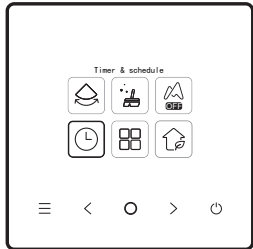

Select the timer function on the menu, and press "○" for confirmation. After entering the timer interface, press "<" or ">" to select the corresponding timer, and press "○" to start function setting.

- 1. Timer off:** Enter the timer off interface, press "<" or ">" to set the power-off time, and press "○" for confirmation and return to the home page to display the timer period.
- 2. Timer on:** Enter the timer on interface, press "<" or ">" to set the power-on time, and press "○" for confirmation and return to the home page to display the timer period.
- 3. Schedule:** Enter the schedule interface. You may turn on more than one schedule. When a schedule is enabled, the air conditioner will go on and off at the specific times. The parameters and operation cycles of all schedules are configurable.

Schedule

When a schedule is enabled, the air conditioner will go on and off at the specific times. Schedule include regular schedule and simple schedule, among which regular timers are provided with three schedule templates. The Schedule enables you to set the power-on/off time, the cycle of operation, and the schedule command. Press "<" or ">" to switch the set object, and press "○" to switch the settings.



Set command:

(1) Simple Schedule

You can set up to five commands, each of which contains the time and power-on/off information. Press "<" or ">" to switch the set object, and press "○" to switch the settings. Upon the setting, press "≡" to save the settings and return.

(2) Schedule

You can set up to five commands, each of which contains the time, mode, fan speed and set temperature. Press "<" or ">" to switch the set object, and press "○" to switch the settings. Upon the setting, press "≡" to save the settings and return.



Simple Schedule



Schedule



CAUTION

- There should not be more than one schedule command at the same time. Otherwise, a conflict may occur.
- Complete the date setting before the first schedule timer setting.

- **Delayed off**

This function is only effective after the schedule is enabled. After delayed off is set, the air conditioner will delay its shutdown in accordance with the set delay based on the original weekly timed power-off time.



CAUTION

- Delayed off is one-off. After executing a delayed-off command, you have to set another delayed-off command to execute such function again.

Self-cleaning

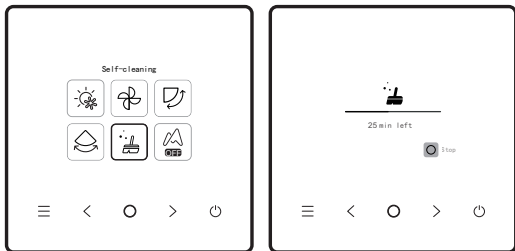

Select the self-cleaning function on the menu.

The self-cleaning process takes approximately 50 minutes and falls into four steps:

Pretreatment ➡ Icing ➡ De-icing and Rinsing ➡ Drying



CAUTION

- You can quit self-cleaning by pressing " ○ " to stop self-cleaning or pressing " ⏻ " to stop directly.
- Only for IDU models with self-cleaning function.
- When self-cleaning is enabled, all IDUs (sharing the same ODU) start the process of self-cleaning.
- During the process of self-cleaning, the IDUs may blow out cold or hot air.

ETA

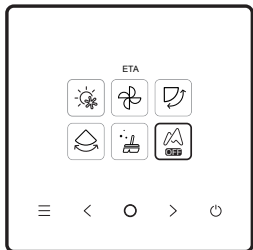

Select the ETA function on the menu, and press "○" to enable or disable the ETA function. The ETA function is real-time energy saving.

IAQ monitoring

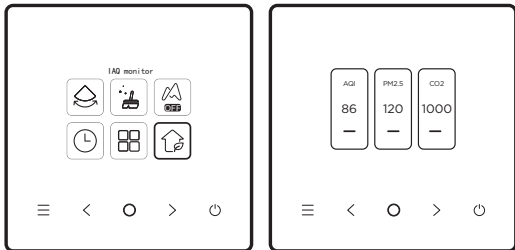

Select the IAQ function on the menu, and check the air quality indicators such as AQI, PM_{2.5} and CO₂ in real time. Indoor air quality monitoring requires adequate configuration of the IDU.



CAUTION

Only for IDUs with IAQ function.

One-to-more

One wired controller can control more than one IDU (up to 16 IDUs). One-to-more control includes group control and separate control. Under group control, the device sends commands to all IDUs in a unified manner. Under separate control, the device sends commands to any IDU in the system.

(1) Group one-to-more control

Enable the one-to-more function by entering the Engineering menu > IDU Settings > Site Configs. Once this function is enabled, the system enters the group one-to-more control by default. Under group control, the device sends commands to all IDUs and all IDUs execute the same commands. The main interface of the device under group one-to-more control is the same as that under one-to-one control. The function in the list should be subjected to the IDU.

(2) Separate one-to-more control

Under group one-to-more control, you can switch to separate control through the separate one-to-more control in the list. Under separate control, the main interface of the device switches to the main interface of separate control.

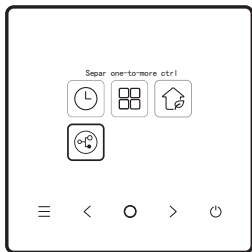

Separ one-to-more control

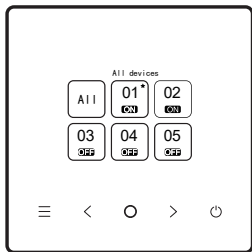

Main interface of separate control

On the main interface of separate one-to-more control, press "≡" to quit from such control. Press "<" or ">" to switch the control object. The control object can be all IDUs or any IDU. Upon selection of the control object, press "⏻" to enable rapid power on/off. Press "○" to set the parameters.

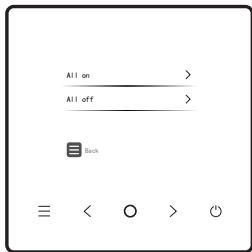

Fast startup

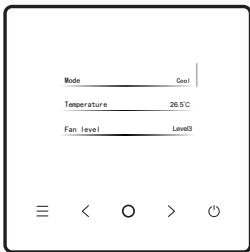

Setting

i INFORMATION

- Under separate control, you can enable swing setting in "Engineering Menu".

Settings

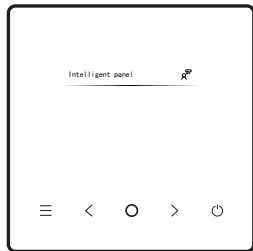

Select the setting on the menu, and press "○" for confirmation. After entering the function setting interface, press "<" or ">" to switch the function, and press "○" to enable the selected function.

ECO: After eco is enabled, the home page will show a icon "eco".

Sterilization: After sterilization is enabled, the home page will show a



sterilization icon "  ".

CAUTION

- It works only with the IDU with sterilization feature.
- The sterilization module stops when the swing function is enabled, and does not resume operation until the swing function is disabled.

Sleep: After sleep is enabled, the home page will show a sleep icon.



The sleep function is only applicable to cooling and heating modes and unavailable for auto, dry and fan modes.

With sleep enabled, it will be cancelled after manual power-off or mode switching. You have to re-enable this function.

Auxiliary heater: The auxiliary heater has four modes:



Auto Operation of Auxiliary Heater, Auxiliary Heater Enabled, Auxiliary Heater Disabled, and Auxiliary Heater Used Separately.





CAUTION

- **Auto Operation of Auxiliary Heater:** Upon power on, the air conditioner will determine whether to start the auxiliary heater automatically based on the ambient temperature in heating mode. At this moment, the air conditioner operates in "Auto Operation of Auxiliary Heater" mode.
- **Auxiliary Heater Used Independently:** The auxiliary heater can be used independently without starting the compressor. Please contact the local dealer about the function.
- **The auxiliary heater can only be started in heating mode.** The auxiliary heater is an additional heating component to the air conditioner, but the power consumption will increase after the auxiliary heater starts working.

Powerful operation: After powerful operation is enabled, the IDU will accelerate cooling/heating. Powerful operation is only available for cooling or heating mode. After powerful operation is enabled, the maximum runtime of the IDU is 30 minutes. After powerful operation is disabled, the IDU will be controlled normally. Powerful operation will quit in case the operating mode or fan speed is changed.

Air flow setting: The wired controller can set the IDU air flow to "Comfortable" or "Off". If the air flow is set to "Comfortable", the fan speed and swing angle of the IDU will automatically adjust to a relatively comfortable level. This function only applies to IDUs with air flow setting feature.

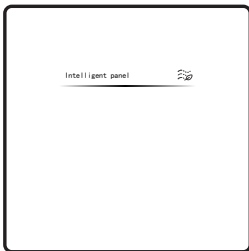

CAUTION

Only for IDUs with air flow setting function.

APP control

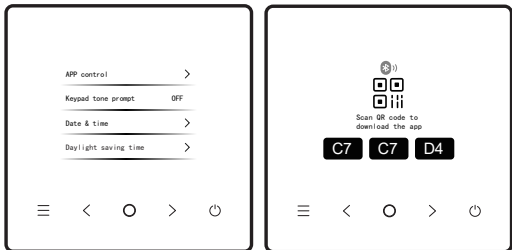

When smart networking is enabled, a QR code will appear. You can scan the QR code to download APP, and control your smart devices with this APP.

iLetComfort appliances networking guidelines

- 1 Download iLetComfort App
Scan the QR code below, or search for "iLetComfort" in Google play(Android devices) or App Store (ios devices) to download the app;



2 Register or Login account

Open the app and create a user account, if you already have one, just log in.



3 Add your appliance

Tap the "+" icon to add home appliance to your iLetComfort account.

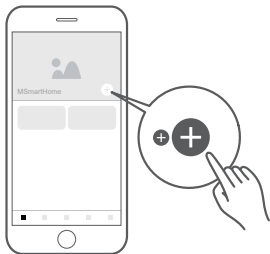

4 Connected to the network

Follow the instructions in the app to set up the WiFi connection. If the network connection fails, please refer to the App tips for operation.

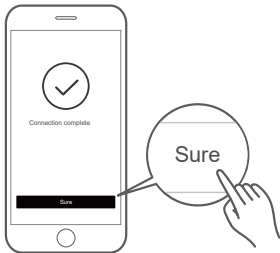

 **NOTE**

Notes on networking :

- When the product is connected to the network, please make sure that the mobile phone is as close as possible to the product.
- According to the App tips, if the product only supports 2.4GHZ WiFi communication, please note that the 2.4GHz network is selected for connection.
- WiFi router SSID names contain only alphanumeric values are recommended . If special characters, punctuation marks or spaces are used it might prevent the SSID name from showing up in the available networks to join in the App. Try it and if the SSID shows up then it is ok to use, otherwise log into the router and change the SSID name.
- A large number of devices on the WiFi router can affect network stability, there is no way that manufacturer can advise a specific number limitation as this depends on router quality and many other factors.
- If the router or WiFi name and WiFi password change, please repeat the above process to reconnect to the

network.

- As the product technology is updated, the content of App may change, and the actual display in App shall prevail.

WiFi information

WiFi transmit frequency range:2.400~2.4835 GHz
EIRP not more than 20dbm

Keypad tone prompt

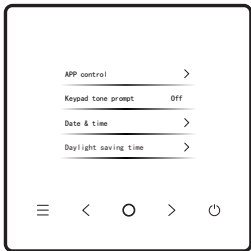
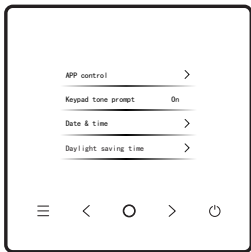

After "Keypad tone prompt" is enabled, the wired controller will operate in silence.

You can press "○" to enable or disable the function.

Quiet IDU

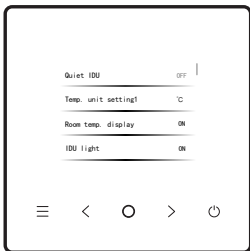
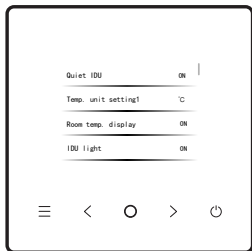

After "Quiet IDU" is enabled, the IDU will operate in silence.
You can press " ○ " to enable or disable the function.

Temperature unit setting

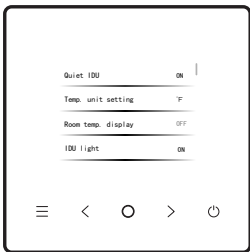
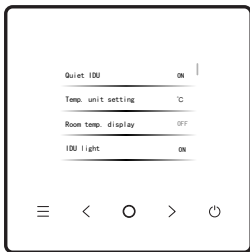

The temperature unit is Celsius by default. You can manually switch the unit between Celsius and Fahrenheit.

You can press " ○ " to enable or disable the temperature unit.

Room temperature display

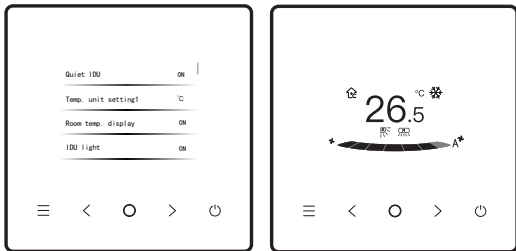

After the room temperature display is enabled, if you return to the home page and does not operate the device, the device will automatically display the room temperature and presents a room temperature icon.

You can press "○" to enable or disable the function.



CAUTION

- In auto mode, the room temperature is displayed forcibly.

IDU light

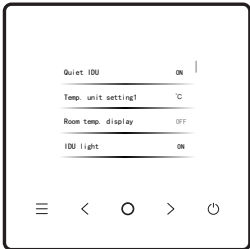
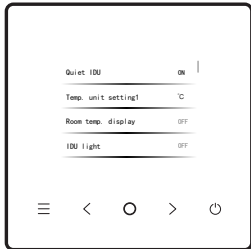

After the IDU light is enabled, the IDU display LED will light up. After the IDU light is disabled, the IDU display LED will turn off. You can press " ○ " to turn on or off the IDU light.

Backlight time

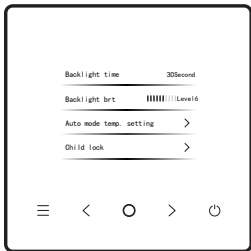
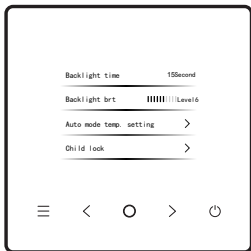

The backlight time can be set to 15s, 30s, or 60s. After the setting, if the device fails to receive any command within the set backlight time, it will enter the standby interface.

You can press " ○ " to adjust the backlight time.

Backlight brightness

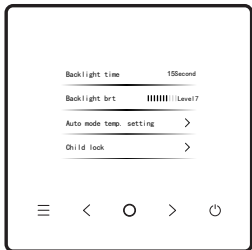
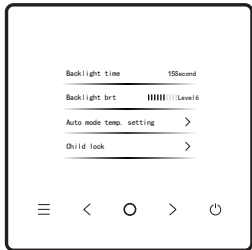

The backlight brightness has 10 levels, used to set the display brightness of the device. The brightness increases from level 1 to 10. You can press " ○ " to adjust the backlight brightness.

Temperature setting in auto mode

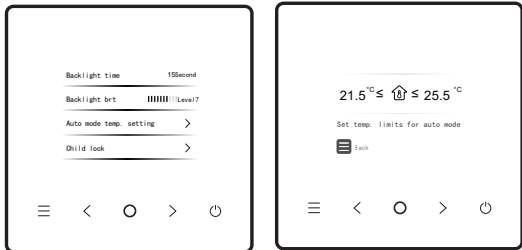

The temperature setting in auto mode enables you to set the temperature in auto cooling/heating mode, and maintain the indoor temperature within the set range.

Press "○" to enter the temperature setting in auto mode, press "○" to select an item, and press "<" and ">" to adjust the range.

Child lock

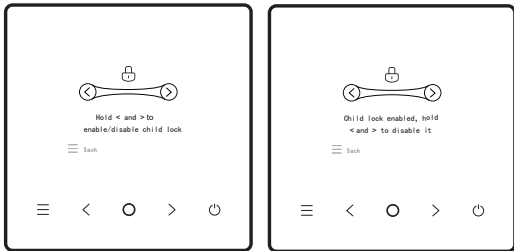

The child lock serves to prevent mis-operation of the device. After it is enabled, the buttons of the device will be locked and cannot be operated until the child lock is unlocked.

Press "<" and ">" at the same time to enable the child lock, and press "<" and ">" at the same time to disable the child lock.

Date and time setting

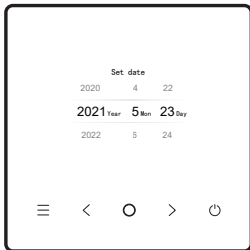
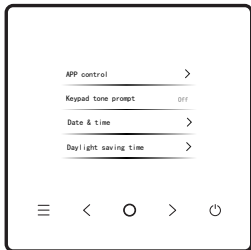

Date and time

You can select the network time (Internet connection required) or manually set the time.

Find the date and time in the function setting interface, find the time display mode, and press "○" to enter the setting interface. Then, press "<" and ">" to set the date and time, and press "○" to switch. After the setting, press "≡" to return for settings to take effect.

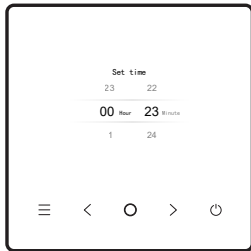

Time display

Time can be displayed in 12-hour or 24-hour format.

Find the date and time in the function setting interface, find the time display mode, and press "  " to enter the setting interface.

Daylight saving time

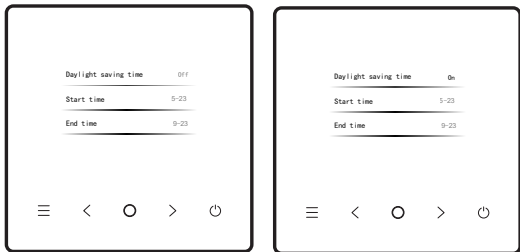

Daylight saving time

You can enable or disable daylight saving time, and set the start time and end time.

Find the date and time in the function setting interface, find daylight saving time, and press "○" to enter the setting interface. Then, press "<" or ">" to set the date and time, and press "○" to switch. After the setting, press "≡" to return for settings to take effect.

Away from home

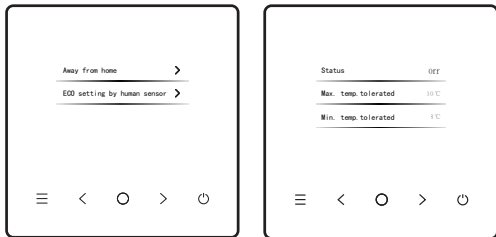

Away from home

You can enable or disable Away from home, and set the Max. temp.tolerated and Min. temp.tolerated .

Find the Eco options in the function setting interface, find Away from home, and press "○" to enter the setting interface. Then, press "<" or ">" to set the Status,Max. temp.tolerated and Min. temp.tolerated , and press "○" to switch. After the setting, press "≡" to return for settings to take effect.

Language

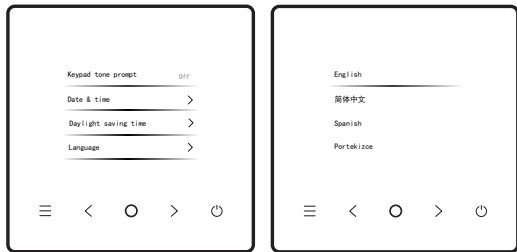

Language

You can enter the language to select your preferred language, the system will enter in the currently selected language.

i INFORMATION

The following language selection page will appear when the wired controller is powered on for the first time.



2.3 Troubleshooting

Error code

Menu	Error	Remarks
C51	Communication fault between wired controller and IDU	SDV6 / 3rd IDU
CE9		SDV5 / 2rd IDU

Error display



1. In case any IDU or ODU fails, the wired controller displays the fault code. In case a communication fault occurs between the wired controller and any of the IDUs, the wired controller reports "C51".
2. The wired controller can record up to 10 faults, each of which includes the address of the faulty device, the fault code, and the time when the fault occurs.

2.4 FQA

- **The air conditioner is not working, but prompts that neither cooling nor heating option can be set. What should I do?**
The set mode is inconsistent with the operating mode of ODU. Please change the set mode to cooling/heating.

- **The word "Filter" is displayed on the operation panel. What should I do?**
Please contact the after-sales service to clean or replace the filter/heat exchanger. Please contact your local dealer.

- **What are the possible causes if the air conditioner is not running as strongly as it should be?**
Please check in the following sequence:
 1. Whether the set mode is cooling or heating;
 2. Whether the louvers of the air outlet face down;
 3. Whether there is any barrier 20 cm around the IDU;
 4. Whether the IDU is clogged and needs to be cleaned.
 5. If the problem persists, Please contact your local dealer.

- **Why does the air outlet of air conditioner drip?**

The indoor air humidity is too high. Please close the doors and windows.

- **Why does the ODU of air conditioner drip?**

1. During cooling in summer, condensation water generated by the unit is discharged to the outside through the IDU drainage pipe. If the drainage pipe is close to the ODU, the condensation water may be mistaken for the water leaked from the ODU. The ODU does not drain any water during cooling.
2. During heating in winter, the ODU may be frosted. Then, the unit will defrost and the defrosted water will flow from the drainage outlet at the bottom of the ODU. This is a normal phenomenon instead of a fault of the air conditioner. To deal with this, you may contact the after-sales personnel or the installer to install an ODU drainage pipe.

- **Why does air conditioner fail to start after it is powered on?**
In winter, it takes some time for your air conditioner to warm up. Please wait a few minutes.
- **Why does air conditioner keep operating after it is powered off?**
After air conditioner is powered off, it operates for a while to eliminate the moisture, so as to reduce the possibility of mould growth.
- **Why are the air conditioner functions non-adjustable?**
If the display panel presents a lock icon, the air conditioner is locked. In this case, please contact the air conditioner system administrator.

3 INSTALLATION

3.1 Precautions for Installation

- To ensure correct installation, please read these installation instructions.
- The content provided here covers warnings, which contain important information about safety that must be followed.



WARNING

- Entrust the local distributor or local service agent to appoint a qualified technician to perform the installation. The user must not install the unit.
- Do not knock, throw, or indiscriminately disassemble the unit.
- The wiring must be compatible with the wired controller current.
- Use specified cables. Do not apply external force to the wiring terminals.

- The wired controller line is a low-voltage circuit, which cannot come into direct contact with any high-voltage line or share the same wiring tube with any high-voltage line. The minimum spacing of wiring tubes should be 300 to 500 mm.
- Do not install the wired controller in a corrosive, flammable or explosive environment or at any place with oil mist (such as a kitchen).
- Do not install the wired controller in damp places. Keep it out of direct sunlight.
- Do not install the wired controller when it is powered on.
- Please install the wired controller after wall painting; otherwise, water, lime and sand may enter the wired controller.

3.2 Basic Parameters

Items	Description
Rated voltage	DC18V
Wiring size	RVVP-0.75mm ² × 2
Operating environment	-5°C ~ 43°C
Humidity	≤ RH90%

3.3 Accessories

Please check that you have all the following parts:

No.	Name	Quantity
1	Wired controller	1
2	Philips head screw, M4×25	2
3	Installation and Operation Manual	1
4	Plastic support bar	2
5	Bottom cap of the wired controller	1
6	Wood screw ST4X20	3
7	Wall plugs	3

Prepare the following parts in the field:

No.	Name	Quantity	Remarks
1	Flush-mounted electrical box	1	Embedded into the wall
2	2-core shielded cable	1	RVVP-0.5 mm ² ×2, embedded into the wall
3	Wiring tubes (insulation suite)	1	Embedded into the wall; maximum wiring length: 200 m
4	Big Phillips screwdriver	1	Used to install cross recessed head screws
5	Small slotted screwdriver	1	Used to remove the rear casing of wired controller

3.4 Installation

3.4.1 Installation Dimensions

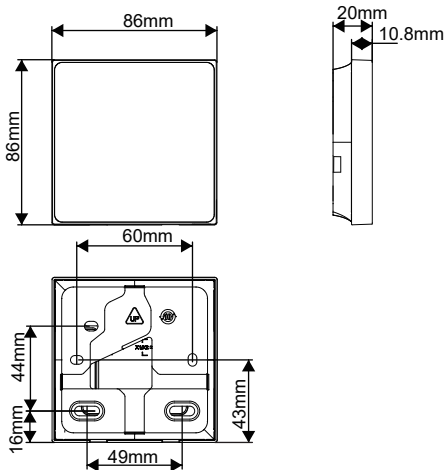

3.4.2. Wiring

One-to-one/two-to-one system

- Applicable to bi-directional communication between a wired controller and an IDU.
- One-to-one system: One wired controller controls one IDU. Two-to-one system: Two wired controllers control one IDU. Parameters displayed on the wired controller vary with the parameters of the IDU. The data is updated in real time.
- Communication cables between an IDU and a wired controller (X1, X2) may be connected in reverse order.
- For a two-to-one system, one controller will be the master controller while the other will be the slave controller.

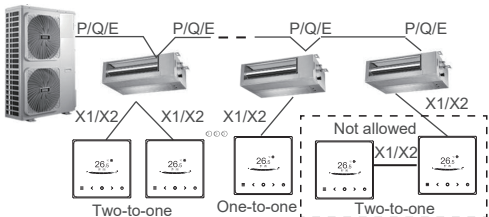

i INFORMATION

For both a one-to-one system and a two-to-one system, the maximum wiring length is 200 m.

One-to-more system (only available for SDV6 IDU)

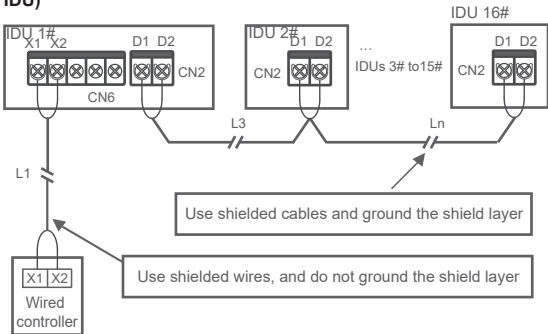

i INFORMATION

Set one wired controller to control more than one IDU. After the communication between the wired controller and IDUs lasts for about 3 minutes and 30 seconds, then the controller can be used normally and control commands can be implemented.

Installation of the rear casing of the wired controller

- 1 Take the screws and plugs from the accessory bag.
- 2 Mount the rear casing to a flat surface.



ST4X20 wood
screws and wall plugs

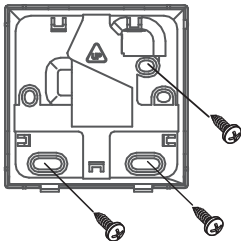

i INFORMATION

Be careful not to distort the rear casing by overtightening the mounting screws.

NOTE

When mounting the rear casing to a flush-mounted electrical installation box inside a wall, make sure that that wall is completely flat.

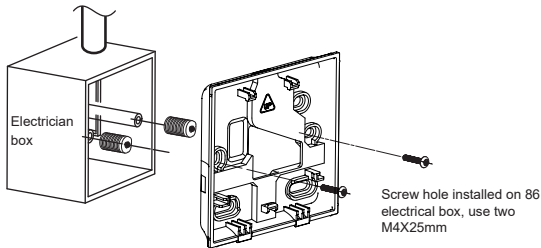

When installed on the wall:

The wire can be placed outlet or inside. Wire outlet have four side to select.

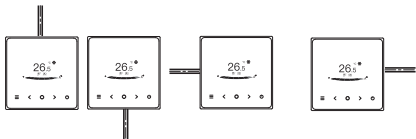
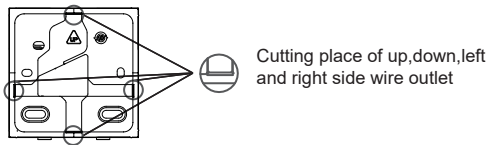

Up, down, left and right side wire outlet

Lead the 2-core shielded cable through the wiring hole in the bottom cap of the wired controller, and use screws to reliably fasten the shielded cable onto terminals X1 and X2. Then fix the bottom cap of the wired controller onto the electrical box by using pan head screws.

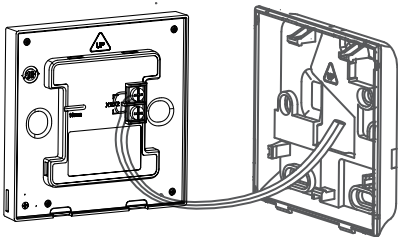

NOTE

- Do not perform wiring operations on energized parts. Make sure that you remove the wired controller before proceeding. Otherwise, the wired controller may be damaged.
- Do not overtighten the pan head screws; otherwise, the bottom cap of the wired controller may deform and cannot be levelled on the wall surface, which makes it difficult to install or not securely installed.

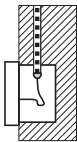

86Electrician box



wire inside

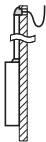

wire outlet

Avoid the water enter into the wired remote controller, use trap and putty to seal the connectors of wires during wiring installation.

Buckle the wired controller and the rear cover as shown in the following figure.

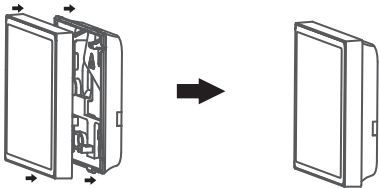

When they are correctly buckled

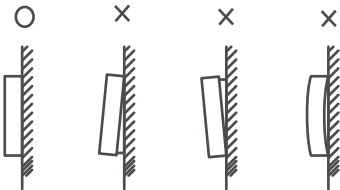

NOTE

- Make sure that no cables are clamped when buckling the wired controller and bottom cap.
- The wired controller and bottom cap should be installed correctly. Otherwise, they may get loose and fall apart.

3.5 Engineering Menu

3.5.1 Parameter settings of the wired controller

- Parameters can be set in the power-on or power-off state.
- Hold "≡" and ">" for 3 seconds to enter the parameter setting interface.
- After entering the parameter setting interface, Press "<" and ">" to switch the parameter. Set parameters according to the Table of Parameter Settings. Press "○" to enter the parameter setting interface. Then press "<" and ">" to change parameter value and press "○" to save changes.
- Press the "≡" button to return to the previous page until exiting the parameter setting or exiting the parameter setting after 60s without any operation.
- When it is in the parameter settings page, the wired controller does not respond to any remote control signal.

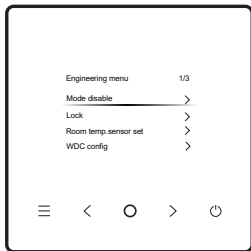

3.5.2. Engineering Menu

Menu	Submenu	Setting
Engineering Menu	Mode disable	Auto, Cool, Heat, Fan, Dry
	Lock	Set temp.
		Speed
	Room temp. sensor set	Room temp. sensor position
		Room temp. sensor compensation
	WDC config	For details, see the "WDC config"
	IDU settings	For details, see the "IDU settings"
	Set IDU address	Set IDU address
	ODU settings	For details, see the "ODU settings"
	System running status query	Fault info
		ODU info
		IDU info
	IDU time	WDC info
	ODU time	Runtime
Fan 1 runtime		
Fan 2 runtime		

Menu	Submenu	Setting
Engineering Menu	ODU time info	comp.1runtime
		comp.2runtime
	Other	Restore Settings
		Self-check

3.5.3 WDC Configuration

Menu	Submenu	Third-level menu	Default	Remarks
WDC config	Set main/sec. wired ctrl.	main/second	Master WDC	
	0.5°C displayed or not	Set temp. format: 0.5/1	0.5	
	Set temp. range /cool and heat	Set upper and lower temp. limits in cooling/heating mode	2nd IDU: 17°C-30°C; 3rd IDU: 16°C-30°C	
	Rem control rcpt of WDC	Enable/Disable	Enable	
	WDC auto restart	Enable/Disable	Enable	
	Perf. degradation	On/Off	Off	SDV6 IDU
	Filter state	On/Off	Off	SDV6 IDU
	Filter clean reminder	No filter reminder function 500h, 1000h, 2500h, 5000h	500h	
	Filter reset			
	WDC light	On/Off	On	
	Separ one-to-more ctrl.swing	On/Off	Off	SDV6 IDU
	After hours	30 min, 60 min, 90 min, 120 min, 180 min, 240 min, invalid	Invalid	

3.5.4 IDU Set Items

SDV5 protocol

IDU set item	Parameter name	Parameter range	Remarks
Site Config	Set Static pressure of IDU	00/01~19/FF	The IDU sets the static pressure based on the set gear, FF (VRF unit: main board DIP of IDU; other models: reserved)
	On-site air flow adjustment factor	00/01	00: 1, 01: 1.1
IDU setting	IDU buzzer	00/01	00: Silent : 01: Ring
	Select EXV opening in heating standby	00/01/02/FF	00: 56P, 01:72P, 02: 00P; FF: IDU DIP
	Mode switch interval in auto mode (min)	00/01/02/03	00: 15min, 01: 30min, 02: 60min, 03: 90min
	Auto restart	00/01	00: No 01:Yes
	Up/down swing	00/01	00: No 01:Yes
	Left/right swing	00/01	00: No 01:Yes
	Rem control rcpt of IDU display panel	00/01	00: Receive; 01: Not receive
	Aux heater	00/01	00: Not available; 01: Available
Set IDU address		0-63	/

IDU set item	Parameter name	Parameter range	Remarks
IDU setting	Set od.temp.value(aux heater on)	Celsius: -5 to 20 Fahrenheit: 23 to 68	1 C or 1 F
	Set outdoor temp. when the third-party heater works separately	00/01/02/03/ 04/05/06/07/ 08/09/10/11/ 12/13/14/15/ 16/17	00: No limit; 01: -16°C/4°F; 02: -14°C/7°F; 03: -12°C/10°F; 04: -9°C/15°F; 05: -7°C/20°F; 06: -4°C/25°F; 07: -1°C/30°F; 08: 2°C/35°F; 09: 4°C/40°F; 10: 7°C/45°F; 11: 10°C/50°F; 12: 13°C/55°F; 13: 16°C/60°F; 14: 18°C/65°F; 15: 21°C/70°F; 16: 24°C/75°F; 17: 27°C/80°F
Fan speed setting	Upper limit of automatic fan speed in cooling mode	04/05/06/07	04: Speed 4; 05: Speed 5; 06: Speed 6; 07: Speed 7
	Upper limit of automatic fan speed in heating mode	04/05/06/07	04: Speed 4; 05: Speed 5; 06: Speed 6; 07: Speed 7
	Air flow setting at fan speed 7	00/01	00: Constant speed; 01: Constant air flow
	Fan speed setting in heating standby mode	00/01/14	00: Thermal; 01: Speed 1; 14: Fan speed before going to standby mode
	Time to stop the fan of IDU in heating mode (Thermal)	00/01/02/03/04/ FF	00: Fan on; 01: 4 min; 02: 8min; 03: 12min; 04: 16min; FF: Main board DIP

IDU set item	Parameter name	Parameter range	Remarks
Temp. setting	IDU's anti-cold wind temperature setting in heating mode	00/01/02/03/FF	Common IDUs (models 1, 3, 4, 6, and 8): 00: 15; 01: 20; 02: 24; 03: 26; FF: Invalid
			FAPU (models 2 and 7): 00: 14; 01: 12; 02: 16; 03: 18; FF: Reserved
	Cooling return difference temp.	00/01/02/03/04	00: 1°C; 01: 2°C; 02: 0.5°C; 03: 1.5°C; 04: 2.5°C
	IDU heating temp. compensation	00/01/02/03/04/FF	VRF unit: 00: 6°C; 01: 2°C; 02: 4°C; 03: 6°C; 04: 0°C; FF: main board DIP of master IDU Split uni: 00: 6°C; 01: 2°C; 02: 4°C; 03: 8°C; 04: 0°C; FF: reserved Mini VRF unit: 00: 6°C; 01: 2°C; 02: 4°C; 03: 8°C; 04: 0°C; FF: Reserved

IDU set item	Parameter name	Parameter range	Remarks
Temp. setting	IDU cooling temp. compensation	VRF unit: 00/01/FF Split unit: 00/01/02/03/FF Mini VRF unit: 00/01/02/03/04/FF	VRF unit: 00: 0°C; 01: 2°C; FF: main board DIP of IDU Split unit: 00: 0°C; 01: 1°C; 02: 2°C; 03: 3°C; FF: Reserved Mini VRF unit: 00: 0°C; 01: 1°C; 02: 2°C; 03: 3°C; 04: -1°C; FF: Reserved
Other settings	Sterilization setting	00/01	00: Sterilization unavailable; 01: Plasma sterilization
	Drying time at self-cleaning	00/01/02/03	00: 10 min; 01: 20 min; 02: 30 min; 03: 40 min
Energy conservation option	Initial static pressure detection	00/01	00: Not reset initial static pressure; 01: Reset initial static pressure
FAPU setting	Fresh air dry contact 1 - fan	00/01	00: Disconnect; 01: Enable
	Fresh air dry contact 2 - economizer	00/01	00: Disconnect; 01: Enable
	Fresh air dry contact 3 - humidifier	00/01	00: Disconnect; 01: Enable

SDV6 protocol

IDU set item	Parameter name	Parameter range	Remarks
Site Config	Static pressure setting of IDU	00/01~19/FF	The IDU sets the static pressure based on the set gear, FF (VRF unit: main board DIP of IDU; other models: reserved)
	High ceiling setting	00/01/02	00: 3 m; 01: 4 m; 02: 4.5 m
	On-site air flow adjustment factor	00/01/02/03/04/05/06	00: 1; 01: 1.05; 02: 1.1; 03: 1.15; 04: 0.95; 05: 0.9; 06: 0.85
	Q4/Q4 min air outlet closed 1	Free control/Close	00: Free control; 01: Close
	Q4/Q4 min air outlet closed 2	Free control/Close	00: Free control; 01: Close
	Q4/Q4 min air outlet closed 3	Free control/Close	00: Free control; 01: Close
	Q4/Q4 min air outlet closed 4	Free control/Close	00: Free control; 01: Close
	Cooling/heating only for IDU	Cooling and heating / Cooling only	
	One-to-many of WDC enabled	No/ Yes	
IDU setting	IDU buzzer	Only panel/Silent/Ring	
	EXV opening selection during heating standby	224P/288P/00P /Auto regulation	
Set IDU address		0-63	For details, see the "Set IDU address"

IDU set item	Parameter name	Parameter range	Remarks
IDU setting	Mode switch interval in auto mode (min)	15min; 30min ; 60min; 90min	
	Auto restart	No; Yes	
	Rem control rcpt of IDU display panel	Receive; Not receive	
	Set outdoor temp. when the auxiliary heater is on	Celsius degree: -25 to 20 Fahrenheit: -13 to 68	1C or 1F

IDU set item	Parameter name	Parameter range	Remarks
IDU setting	Set outdoor temp. when the third-party heater works separately	00/01/02/03/04/ 05/06/07/08/09/ 10/11/12/13/14/ 15/16/17	00: No limit; 01: -16°C/4°F; 02: -14°C/7°F; 03: -12°C/10°F; 04: -9°C/15°F; 05: -7°C/20°F; 06: -4°C/25°F; 07: -1°C/30°F; 08: 2°C/35°F; 09: 4°C/40°F; 10: 7°C/45°F; 11: 10°C/50°F; 12: 13°C/55°F; 13: 16°C/60°F; 14: 18°C/65°F; 15: 21°C/70°F; 16: 24°C/75°F; 17: 27°C/80°F
	Indoor temp. when auxiliary heater is on	Celsius: 10 to 30 Fahrenheit: 50 to 86	1 C or 1 F

IDU set item	Parameter name	Parameter range	Remarks
IDU setting	T1 temp. difference when auxiliary heater is on	0-7	0 to 7 represent 0 to 7°C/°F
	T1 temp. difference when auxiliary heater is off	0-10	0 to 10 represent -4 to 6°C/°F
	Auto dry function	Yes;No	00:No;01:Yes
Fan speed setting	Upper limit of automatic fan speed in cooling mode	Speed 4; Speed 5; Speed 6; Speed 7	
	Upper limit of automatic fan speed in heating mode	Speed 4; Speed 5; Speed 6; Speed 7	04: Speed 4; 05: Speed 5; 06: Speed 6; 07: Speed 7
	Air flow setting at fan speed 7	Constant speed; Constant air flow	
	Fan speed setting in cooling standby mode	Delayed fan shutdown; Speed 1;Speed 2; Speed 3;Speed 4; Speed 5;Speed 6; Speed 7;Fan speed before going to standby mode	
	Standby fan speed L1 range in dry mode	Fan off; L1; L2; Speed 1	
	Fan speed setting in heating standby mode	Thermal; Speed 1; Fixed gear 1	
	Time to stop the fan of IDU in heating mode (Thermal)	Fan off; 4min;8min; 12min;16 min (SDV6 protocol)	

IDU set item	Parameter name	Parameter range	Remarks
Temp. setting	IDU's anti-cold wind temperature setting in heating mode	00/01/02/03/04	Common IDUs (models 1, 3, 4, 6, and 8): 0: 15; 1: 20; 2: 24; 3: 26; 04: Invalid FAPU (models 2 and 7): 0:14; 1:12; 2:16; 3:18; 04: Invalid
	Cooling return difference temp.	1°C; 2°C; 0.5°C; 1.5°C; 2.5°C	
	Heating return difference temperature	1°C; 2°C; 0.5°C; 1.5°C; 2.5°C	
	IDU heating temp. compensation	00/01/02/03/04	00: 6°C; 01: 2°C; 02: 4°C; 03: 8°C; 04: 0°C
	IDU cooling temp. compensation	00/01/02/03/04	00: 0°C; 01: 1°C; 02: 2°C; 03: 3°C; 04: -1°C
	Max. indoor temp. drop D3 in dry mode	00/01/02/03/04	00: 3°C; 01: 4°C; 02: 5°C; 03: 6°C; 04: 7°C

IDU set item	Parameter name	Parameter range	Remarks
Remote and alarm settings	On/Off port logic via remote control	Remote off (closed); Remote off (open)	Note: When powered off remotely, the digital display of wired controller of SDV6 displays d61, while that of SDV5 does not display this code
	Remote ON/OFF control (implemented at the second stage)	00/01	00: Forced OFF control; 01: ON/OFF control
	Remote Off delay	No delay; 1 min; 2 min; 3min; 4min; 5min; 10min	
	Alarm port logic	Alarm upon closing; Alarm upon opening	
	Sterilization setting	Yes/No	
	Drying time at self-cleaning	00/01/02/03	00: 10 min; 01: 20 min; 02: 30 min; 03: 40 min
	Mildew-proof fan runtime (power off in cooling/dry mode, except power off due to faults)	Default ; 60s; 90s; 120s	
	Dirt proof for ceiling	Invalid; Valid	
	Condensation proof	Invalid; Valid	
	Refrigerant leak alarm reset	Not reset; reset	

IDU set item	Parameter name	Parameter range
Energy conservation option	Meta level in cooling mode	Level 1; 01: Level 2; Level 3
	Meta level in heating mode	00: Level 1; 01: Level 2; 02: Level 3
	Initial static pressure detection	Retain initial static pressure; Reset initial static pressure
	Filter ending - initial static pressure setting	10Pa; 20Pa; 30Pa ~19: 200Pa
Fresh air setting	Ambient temp. when preheater is on	5°C; 0°C; (-5)°C

3.5.5 ODU Set Items

Parameter name	Parameter range
Energy rating of ODU	40% to 100%, every 1%
VIP IDU address	0-63
Heating and air supply enabled	Disable; Enable
Silence level of ODU	Level 0 to14

NOTE CONCERNING PROTECTION OF ENVIRONMENT



This product must not be disposed of via normal household waste after its service life, but must be taken to a collection station for the recycling of electrical and electronic devices. The symbol on the product, the operating instructions or the packaging indicate such disposal procedures. The materials are recyclable in accordance with their respective symbols. By means of re-use, material recycling or any other form of recycling old appliances you are making an important contribution to the protection of our environment. Please ask your local council where your nearest disposal station is located.

PRODUCER

SINCLAIR CORPORATION
Ltd. 16 Great Queen Street
WC2B 5AH London
United Kingdom
www.sinclair-world.com

This product was manufactured in China (Made in China).

TECHNICAL SUPPORT

SINCLAIR Global Group s.r.o.
Purkynova 45
612 00 Brno
Czech Republic
Tel: +420 800 100 285 | Fax: +420 541 590 124
www.sinclair-solutions.com | info@sinclair-solutions.com

REPRESENTATIVE

SINCLAIR Global Group
s.r.o. Purkynova 45
612 00 Brno
Czech Republic

