

USER'S MANUAL

CONSOLE SERIES

ASP-xxBI



“Original instructions”

IMPORTANT NOTE:

Read this manual carefully before installing or operating your new air conditioning unit. Make sure to save this manual for future reference.

Contents

OPERATION INSTRUCTIONS

The Refrigerant	1
Precautions	2
1. Part names and their functions	7
2. How to use the remote control to operate the unit	8
3. Maintenance	13
4. Operating guide	16
5. Precautions	18
6. Checking before contact the service man	19

Thank you for selecting our products

One of the benefits awaiting you with our room air conditioner is not only comfort of life but also good health. This operation instruction brings you the many comfort and technological features your unit has to offer. In addition, it provides you vital information about maintenance, service and economical operating. Take the next few minutes to discover how to get your comfort and economy of the operation from your new room air conditioner.

The figures in this manual may be different with the material objects, please refer to the material objects for reference.

This appliance is not intended for use by persons (including children) with reduced physical, sensory or mental capabilities, or lack of experience and knowledge, unless they have been given supervision or instruction concerning use of the appliance by a person responsible for their safety. Children should be supervised to ensure that they do not play with the appliance.

External static pressures at the appliance was tested is 0 Pa
Fuse link: T250 V; 3.15 A

1) Frequency band(s) in which the radio equipment operates : 2400MHz-2483.5MHz
2) Maximum radio-frequency power transmitted in the frequency band(s) in which the radio equipment operates : 20dBm



This marking indicates that this product should not be disposed with other household wastes throughout the EU. To prevent possible harm to the environment or human health from uncontrolled waste disposal, recycle it responsibly to promote the sustainable reuse of material resources. To return your used device, please use the return and collection systems or contact the retailer where the product was purchased. They can take this product for environmental safe recycling.

R32: 675

Explanation of Symbols



Indicates a hazardous situation that, if not avoided, will result in death or serious injury.



Indicates a hazardous situation that, if not avoided, could result in death or serious injury.



Indicates a hazardous situation that, if not avoided, may result in minor or moderate injury.



Indicates important but not hazard-related information, used to indicate risk of property damage.



Indicates a hazard that would be assigned a signal word WARNING or CAUTION.

Exception Clauses

Manufacturer will bear no responsibilities when personal injury or property loss is caused by the following reasons.

1. Damage the product due to improper use or misuse of the product;
2. Alter, change, maintain or use the product with other equipment without abiding by the instruction manual of manufacturer;
3. After verification, the defect of product is directly caused by corrosive gas;
4. After verification, defects are due to improper operation during transportation of product;
5. Operate, repair, maintain the unit without abiding by instruction manual or related regulations;
6. After verification, the problem or dispute is caused by the quality specification or performance of parts and components that produced by other manufacturers;
7. The damage is caused by natural calamities, bad using environment or force majeure.



Appliance filled with flammable gas R32.

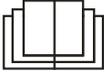

Before use the appliance, read the owner's manual first.



Before install the appliance, read the installation manual first.



Before repair the appliance, read the service manual first.

The Refrigerant

OPERATION INSTRUCTIONS

- To realize the function of the air conditioner unit, a special refrigerant circulates in the system. The used refrigerant is the fluoride R32, which is specially cleaned. The refrigerant is flammable and inodorous. Furthermore, it can lead to explosion under certain conditions. But the flammability of the refrigerant is very low. It can be ignited only by fire.
- Compared to common refrigerants, R32 is a nonpolluting refrigerant with no harm to the ozone layer. The influence upon the greenhouse effect is also lower. R32 has got very good thermodynamic features which lead to a really high energy efficiency. The units therefore need a less filling.

WARNING :

Do not use means to accelerate the defrosting process or to clean, other than those recommended by the manufacturer. Should repair be necessary, contact your nearest authorized Service Centre. Any repairs carried out by unqualified personnel may be dangerous. The appliance shall be stored in a room without continuously operating ignition sources. (for example: open flames, an operating gas appliance or an operating electric heater.) Do not pierce or burn.

Appliance shall be installed, operated and stored in a room with a floor area larger than $X \text{ m}^2$. (Please refer to table "a" in section of " Safety Operation of Inflammable Refrigerant" for Space X.)

Appliance filled with flammable gas R32. For repairs, strictly follow manufacturer's instructions only. Be aware that refrigerants do not contain odour. Read specialist's manual.

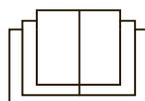

**WARNING****Operation and Maintenance**

- This appliance can be used by children aged from 8 years and above and persons with reduced physical, sensory or mental capabilities or lack of experience and knowledge if they have been given supervision or instruction concerning use of the appliance in a safe way and understand the hazards involved.
- Children shall not play with the appliance.
- Cleaning and user maintenance shall not be made by children without supervision.
- Do not connect air conditioner to multi-purpose socket. Otherwise, it may cause fire hazard.
- Do disconnect power supply when cleaning air conditioner. Otherwise, it may cause electric shock.
- If the supply cord is damaged, it must be replaced by the manufacturer, its service agent or similarly qualified persons in order to avoid a hazard.
- Do not wash the air conditioner with water to avoid electric shock.
- Do not spray water on indoor unit. It may cause electric shock or malfunction.
- After removing the filter, do not touch fins to avoid injury.
- Do not use fire or hair dryer to dry the filter to avoid deformation or fire hazard.

**WARNING**

- Maintenance must be performed by qualified professionals. Otherwise, it may cause personal injury or damage.
- Do not repair air conditioner by yourself. It may cause electric shock or damage. Please contact dealer when you need to repair air conditioner.
- Do not extend fingers or objects into air inlet or air outlet. It may cause personal injury or damage.
- Do not block air outlet or air inlet. It may cause malfunction.
- Do not spill water on the remote controller, otherwise the remote controller may be broken.
- When below phenomenon occurs, please turn off air conditioner and disconnect power immediately, and then contact the dealer or qualified professionals for service.
 - Power cord is overheating or damaged.
 - There's abnormal sound during operation.
 - Circuit break trips off frequently.
 - Air conditioner gives off burning smell.
 - Indoor unit is leaking.
- If the air conditioner operates under abnormal conditions, it may cause malfunction, electric shock or fire hazard.
- When turning on or turning off the unit by emergency operation switch, please press this switch with an insulating object other than metal.
- Do not step on top panel of outdoor unit, or put heavy objects. It may cause damage or personal injury.

**WARNING****Attachment**

- Installation must be performed by qualified professionals. Otherwise, it may cause personal injury or damage.
- Must follow the electric safety regulations when installing the unit.
- According to the local safety regulations, use qualified power supply circuit and circuit break.
- Do install the circuit break. If not, it may cause malfunction.
- An all-pole disconnection switch having a contact separation of at least 3mm in all poles should be connected in fixed wiring.
- Including an circuit break with suitable capacity, please note the following table. Air switch should be included magnet buckle and heating buckle function, it can protect the circuit-short and overload.
- Air Conditioner should be properly grounded. Incorrect grounding may cause electric shock.
- Don't use unqualified power cord.
- Make sure the power supply matches with the requirement of air conditioner. Unstable power supply or incorrect wiring or malfunction. Please install proper power supply cables before using the air conditioner.
- Properly connect the live wire, neutral wire and grounding wire of power socket.
- Be sure to cut off the power supply before proceeding any work related to electricity and safety.

**WARNING**

- Do not put through the power before finishing installation.
- If the supply cord is damaged, it must be replaced by the manufacturer, its service agent or similarly qualified persons in order to avoid a hazard.
- The temperature of refrigerant circuit will be high, please keep the interconnection cable away from the copper tube.
- The appliance shall be installed in accordance with national wiring regulations.
- Installation must be performed in accordance with the requirement of NEC and CEC by authorized personnel only.
- The air conditioner is the first class electric appliance. It must be properly grounding with specialized grounding device by a professional. Please make sure it is always grounded effectively, otherwise it may cause electric shock.
- The yellow-green wire in air conditioner is grounding wire, which can't be used for other purposes.
- The grounding resistance should comply with national electric safety regulations.
- The appliance must be positioned so that the plug is accessible.
- All wires of indoor unit and outdoor unit should be connected by a professional.
- If the length of power connection wire is insufficient, please contact the supplier for a new one. Avoid extending the wire by yourself.

**WARNING**

- For the air conditioner with plug, the plug should be reachable after finishing installation.
- For the air conditioner without plug, an circuit break must be installed in the line.
- If you need to relocate the air conditioner to another place, only the qualified person can perform the work. Otherwise, it may cause personal injury or damage.
- Select a location which is out of reach for children and far away from animals or plants. If it is unavoidable, please add the fence for safety purpose.
- The indoor unit should be installed close to the wall.

1 Part names and their functions

INDOOR UNIT

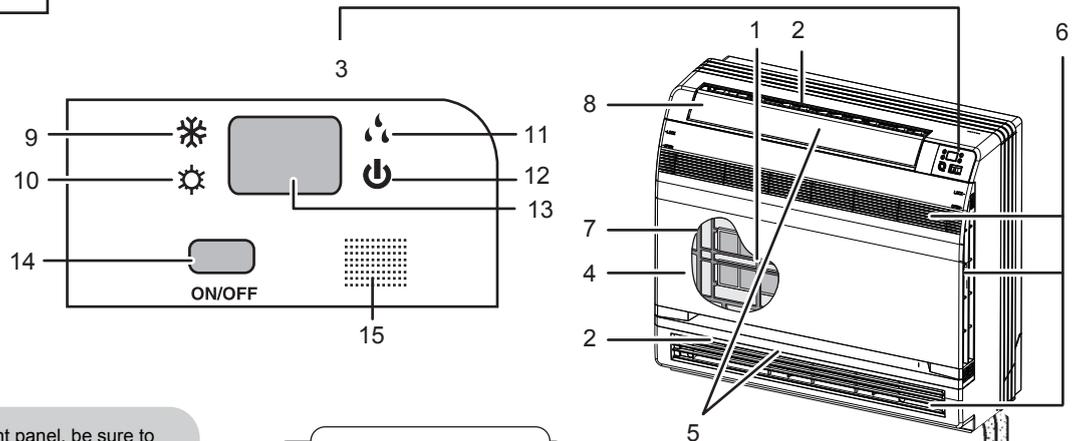

CAUTION

Before opening the front panel, be sure to stop the operation and turn the breaker OFF. Do not touch the metal parts on the inside of the indoor unit, as it may result in injury.

- 1. Titanium Apatite Photocatalytic Air-Purifying Filter:**
 - These filters are attached to the inside of the air filters.

- 2. Air outlet**
- 3. Display**
- 4. Front panel**
- 5. Louvers (vertical blades)**
 - The louvers are inside of the air outlet.
- 6. Air inlet**

- 7. Air filter**
- 8. Flap (horizontal blade)**
- 9. Cool mode lamp**
- 10. Heat mode lamp**
- 11. Dry mode lamp**
- 12. Run lamp**
- 13. LED display**

- 14. Indoor Unit ON/OFF switch:**
 - Push this switch once to start operation. Push once again to stop it.
 - The operation mode refers to the following table.

Model	Mode	Temperature setting	Air flow rate
COOLING ONLY	AUTO	25°C	AUTO
HEAT PUMP	AUTO	25°C	AUTO

- This switch is useful when the remote controller is missing.

- 15. Signal receiver:**
 - It receives signals from the remote controller.
 - When the unit receives a signal, you will hear a short beep.
 - Settings changed.....beep

- 16. Air outlet selection switch**

- 17. Room temperature sensor:**
 - It senses the air temperature around the unit.

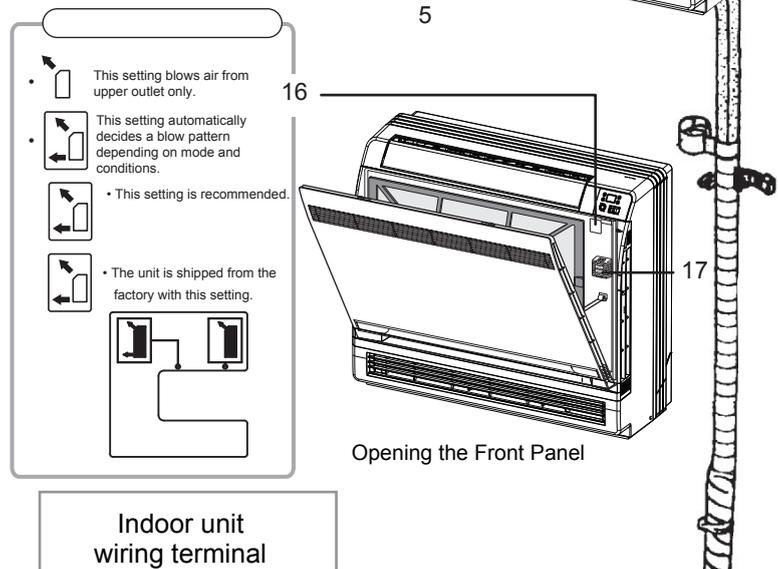

Opening the Front Panel

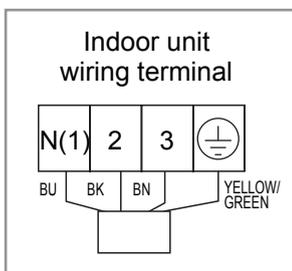

2 How to use the remote control to operate the unit

OPERATION INSTRUCTIONS

Remote Controller Description



- 1 ON/OFF**
Press it to start or stop operation.
- 2 -** : Press it to decrease temperature setting.
- 3 +** : Press it to increase temperature setting.
- 4 MODE**
Press it to select operation mode (AUTO/COOL/DRY/FAN/HEAT).
- 5 FAN**
Press it to set fan speed.
- 6 SWING**
Press it set swing angle.
- 7 I FEEL**
- 8**
Press it to set HEALTH or AIR function.
- 9 SLEEP**
- 10 TEMP**
- 11 QUIET**
Press it to set QUIET function.
- 12 CLOCK**
Press it set clock.
- 13 T-ON|T-OFF**
Press it to set auto-off/auto-on timer.
- 14 TURBO**
- 15 LIGHT**
Press it to turn on/off the light.
- 16 WiFi**

Remote Controller Description

Note:

- This is a general use remote controller, it could be used for the air conditioners with multifunction; For some function, which the model doesn't have, if press the corresponding button on the remote controller that the unit will keep the original running status.

1 ON/OFF :

Press this button to turn on the unit .Press this button again to turn off the unit.

2 —:

Press this button to decrease set temperature. Holding it down above 2 seconds rapidly decreases set temperature. In AUTO mode, set temperature is not adjustable.

3 + :

Press this button to increase set temperature.Holding it down above 2 seconds rapidly increases set temperature. In AUTO mode, set temperature is not adjustable.

4 MODE :

Each time you press this button,a mode is selected in a sequence that goes from AUTO, COOL,DRY, FAN,and HEAT *, as the following:



*Note:Only for models with heating function.

After energization, AUTO mode is defaulted. In AUTO mode, the set temperature will not be displayed on the LED of the indoor, and the unit will automatically select the suitable operation mode in accordance with the room temperature to make indoor room comfortable.

5 FAN :

This button is used for setting Fan Speed in the sequence that goes from AUTO, , , , to , then back to Auto.

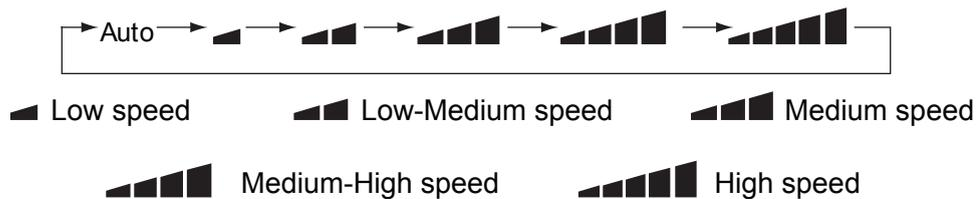

- X-FAN function: Hold fan speed button for 2s in COOL or DRY mode, the icon “” is displayed and the indoor fan will continue operation for a few minutes in order to dry the indoor unit even though you have turned off the unit. After energization, X-FAN OFF is defaulted. X-FAN is not available in AUTO, FAN or HEAT mode.

This function indicates that moisture on evaporator of indoor unit will be blown after the unit is stopped to avoid mould.

- Having set X-FAN function on: After turning off the unit by pressing ON/OFF button indoor fan will continue running for a few minutes. at low speed. In this period, Hold fan speed button for 2s to stop indoor fan directly.
- Having set X-FAN function off: After turning off the unit by pressing ON/OFF button, the complete unit will be off directly.

6 SWING:

Press this button to set up & down swing angle, which circularly changes as below:



This remote controller is universal. If any command , or is sent out, the unit will carry out the command as .

indicates the guide louver swings as:

7 I FEEL:

Press this button to turn on I FEEL function. The unit automatically adjust temperature according to the sensed temperature. Press this button again to cancel I FEEL function.

When I FEEL function is turned on, the remote controller should be put within the area where indoor unit can receive the signal sent by the remote controller.

8 :

Press this button to achieve the on and off of healthy and scavenging functions in operation status.

Press this button for the first time to start scavenging function;

LCD displays "". Press the button for the second time to start healthy and scavenging functions simultaneously; LCD displays "" and "". Press this button for the third time to quit healthy and scavenging functions simultaneously. Press the button for the fourth time to start healthy function; LCD display "". Press this button again to repeat the operation above.

NOTE: This function is applicable to partial of models.

9 SLEEP:

- Press this button, can select Sleep 1 (), Sleep 2 (), Sleep 3 () and cancel the Sleep, circulate between these, after electrified, Sleep Cancel is defaulted.
- Sleep 1 is Sleep mode 1, in Cool mode: sleep status after run for one hour, the main unit setting temperature will increase 1 °C, setting temperature increased 2 °C, the unit will run at this setting temperature; In Heat mode: sleep status after run for one hour, the setting temperature will decrease 1 °C, 2 hours, setting temperature will decrease 2 °C, then the unit will run at this setting temperature.
- Sleep 2 is sleep mode 2, that is air conditioner will run according to the presetting a group of sleep temperature curve.
- Sleep 3- the sleep curve setting under Sleep mode by DIY:
 - (1) Under Sleep 3 mode, press "Turbo" button for a long time, remote control enters into user individuation sleep setting status, at this time, the time of remote control will display "1 hour ", the setting temperature "88" will display the corresponding temperature of last setting sleep curve and blink (The first entering will display according to the initial curve setting value of original factory);
 - (2) Adjust "+" and "-" button, could change the corresponding setting temperature, after adjusted, press "Turbo "button for confirmation;
 - (3) At this time, 1 hour will be automatically increased at the timer position on the remote control, (that are "2 hours " or "3 hours " or "8 hours "), the place of setting temperature "88" will display the corresponding temperature of last setting sleep curve and blink;
 - (4) Repeat the above step (2) ~ (3) operation, until 8 hours temperature setting finished, sleep curve setting finished, at this time, the remote control will resume the original timer display; temperature display will resume to original setting temperature.
- Sleep3- the sleep curve setting under SLEEP mode by DIY could be inquired:
 - The user could accord to sleep curve setting method to inquire the presetting sleep curve, enter into user individuation sleep setting status, but do not change the temperature, press "Turbo" button directly for confirmation. Note: In the above presetting or enquiry procedure, if continuously within 10s, there is no button pressed, the sleep curve setting within 10s, there is no button pressed, the sleep curve setting status will be automatically quit and resume to display the original displaying. In the presetting or enquiry procedure, press "ON/OFF" button, "Mode" button, "Timer" button or "Sleep" button, the sleep curve setting or enquiry status will quit similarly.

10 TEMP:

Press this button, could select displaying the indoor setting temperature or indoor ambient temperature. When the indoor unit firstly power on it will display the setting temperature, if the temperature's displaying status is changed from other status to "🏠", displays the ambient temperature, 5s later or within 5s, it receives other remote control signal that will return to display the setting temperature. if the users haven't set up the temperature displaying status, that will display the setting temperature.

11 QUIET:

Press this button, the Quiet status is under the Auto Quiet mode (display "🔇" and "Auto" signal) and Quiet mode (display "🔇" signal) and Quiet OFF (there is no signal of "🔇" displayed), after powered on, the Quiet OFF is defaulted. Note: Under the Quiet mode (Display "🔇" signal), the fan speed is not available.

12 CLOCK :

Press CLOCK button, blinking 🕒 . Within 5 seconds, pressing + or - button adjusts the present time. Holding down either button above 2 seconds increases or decreases the time by 1 minute every 0.5 second and then by 10 minutes every 0.5 second. During blinking after setting, press CLOCK button again to confirm the setting, and then 🕒 will be constantly displayed.

13 T-ON / T-OFF:

Press T-ON button to initiate the auto-ON timer. To cancel the auto-timer program, simply press this button again.

After press of this button, 🕒 disappears and "ON "blinks .00:00 is displayed for ON time setting. Within 5 seconds, press + or - button to adjust the time value. Every press of either button changes the time setting by 1 minute. Holding down either button rapidly changes the time setting by 1 minute and then 10 minutes. Within 5 Seconds after setting, press TIMER ON button to confirm.

Press T-OFF button to initiate the auto-off timer. To cancel the auto-timer program, simply press the button again. TIMER OFF setting is the same as TIMER ON.

14 TURBO:

Press this button to activate / deactivate the Turbo function which enables the unit to reach the preset temperature in the shortest time. In COOL mode, the unit will blow strong cooling air at super high fan speed. In HEAT mode, the unit will blow strong heating air at super high fan speed.

15 LIGHT:

Press LIGHT button to turn on the display's light and press this button again to turn off the display's light. If the light is turned on, 💡 is displayed. If the light is turned off, 💡 disappears.

16 WiFi:

Press "WiFi" button to turn on or turn off WiFi function. When WiFi function is turned on, the "WiFi" icon will be displayed on remote controller; Under status of unit off, press "MODE" and "WiFi" buttons simultaneously for 1s, WiFi module will restore to factory default setting.

- This function is only available for some models.

17 Combination of "+" and "-" buttons: About lock

Press "+" and "-" buttons simultaneously to lock or unlock the keypad. If the remote controller is locked, 🔒 is displayed. In this case, pressing any button, 🔒 blinks three times.

18 Combination of "MODE " and "-" buttons : About switch between Fahrenheit and centigrade

At unit OFF, press "MODE " and "-" buttons simultaneously to switch between °C and °F .

19 Combination of " TEMP " and "CLOCK" buttons : About Energy-saving Function

Press "TEMP" and "CLOCK" simultaneously in COOL mode to start energy-saving function. Nixie tube on the remote controller displays "SE". Repeat the operation to quit the function.

20 Combination of " TEMP " and "CLOCK" buttons : About 8°C Heating Function

Press "TEMP" and "CLOCK" simultaneously in HEAT mode to start 8°C Heating Function Nixie tube on the remote controller displays "Ⓔ" and a selected temperature of "8°C". (46°F if Fahrenheit is adopted). Repeat the operation to quit the function.

21 About Back-lighting Function

The unit lights for 4s when energizing for the first time, and 3s for later press.

Replacement of Batteries

1. Remove the battery cover plate from the rear of the remote controller.
(As shown in the figure)
2. Take out the old batteries.
3. Insert two new AAA1.5V dry batteries, and pay attention to the polarity.
4. Reinstall the battery cover plate.

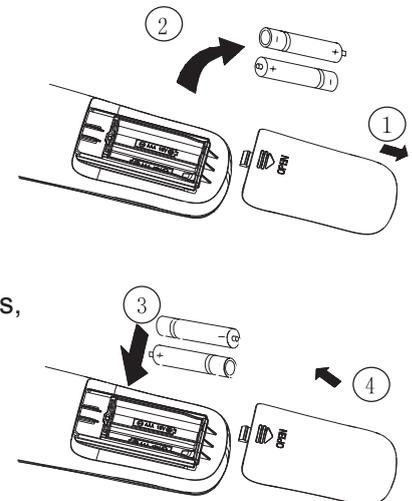

Sketch map for replacing batteries

★ Notes:

- When replacing the batteries, do not use old or different types of batteries, otherwise, it may cause malfunction.
- If the remote controller will not be used for a long time, please remove batteries to prevent batteries from leaking.
- The operation should be performed in its receiving range.
- It should be kept 1m away from the TV set or stereo sound sets.
- If the remote controller does not operate normally, please take the batteries out and reinsert them after 30 seconds. If it still can't operate properly, replace the batteries.

Before inspection and maintenance of the unit. PLEASE set power switch to "OFF" to cut off the power supply.

3.1 Units

- Indoor unit, Outdoor unit and Remote controller

1. Wipe them with dry soft cloth.

- Front panel

1. Open the front panel.

Slide the two stoppers on the left and right sides inward until they click.

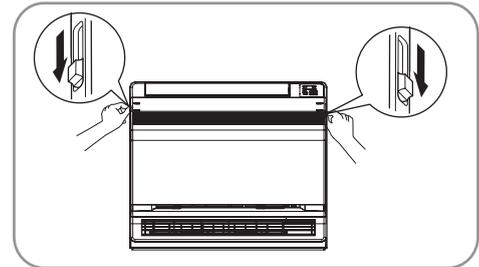

2. Remove the front panel.

- Remove the string.
- Allowing the front panel to fall forward will enable you to remove it.

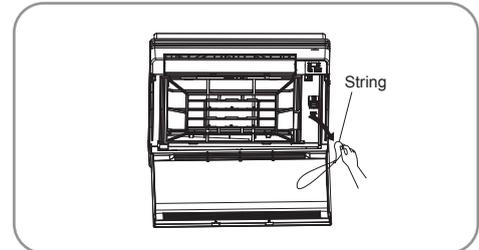

3. Clean the front panel.

- Wipe it with a soft cloth soaked in water.
- Only neutral detergent may be used.
- In case of washing the front panel with water, dry it with cloth, dry it up in the shade after washing.

4. Attach the front panel.

- Insert the front panel into the grooves of the unit (3 places).
- Attach the string to the right, inner-side of the front grille.
- Close the panel slowly.

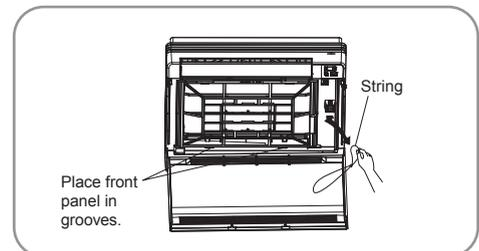

CAUTION

- Don't touch the metal parts of the indoor unit. If you touch those parts, this may cause an injury.
- When removing or attaching the front panel, use a robust and stable stool and watch your steps carefully.
- When removing or attaching the front panel, support the panel securely with hand to prevent it from falling.
- For cleaning, do not use hot water above 40°C, benzine, gasoline, thinner, nor other volatile oils, polishing compound, scrubbing brushes, nor other hand stuff.
- After cleaning, make sure that the front panel is securely fixed.

3.2 Filters

1. Open the front panel.

2. Remove the air filter.

- Press the claws on the right and left of the air filter down slightly, then pull upward.

3. Take off the Titanium Apatite Photocatalytic Air-Purifying Filter.

- Hold the tabs of the frame, and remove the claws in 4 places.

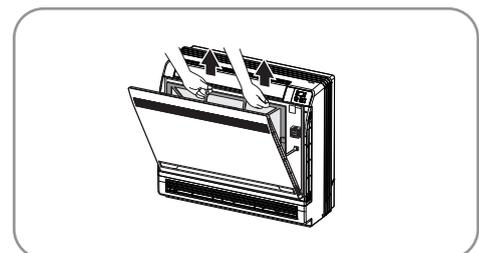

4. Clean or replace each filter.
See figure.

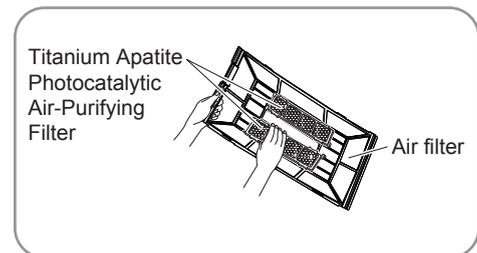

5. Set the air filter and Titanium Apatite Photocatalytic Air-Purifying Filter as they were and close the front panel.
- Operation without air filters may result in troubles as dust will accumulate inside the indoor unit.

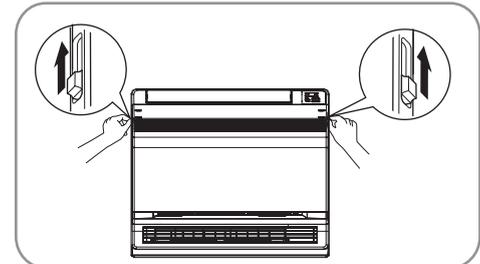

6. Wash the air filters with water or clean them with vacuum cleaner.
- If the dust does not come off easily, wash them with neutral detergent thinned with lukewarm water, then dry them up in the shade.
 - It is recommended to clean the air filters every week.

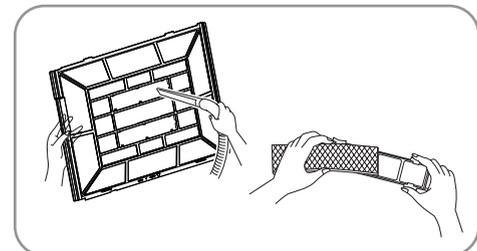

3.3 Titanium Apatite Photocatalytic Air-Purifying Filter

The Titanium Apatite Photocatalytic Air-Purifying Filter can be renewed by washing it with water once every 6 months. We recommend replacing it once every 3 years.

• Maintenance

1. Vacuum dusts, and soak in warm water or water for about 10 to 15 minutes if dirt is heavy.
2. Do not remove filter from frame when washing with water.
3. After washing, shake off remaining water and dry in the shade.
4. Since the material is made out of paper, do not wring out the filter when removing water from it.

• Replacement

Remove the tabs on the filter frame and replace with a new filter.

- Dispose of the old filter as flammable waste.
- Dispose of the old filter as flammable waste.

NOTE

- Operation with dirty filters:

(1) cannot deodorize the air.	(2) cannot clean the air.
(3) results in poor heating or cooling.	(4) may cause odour.

Check

Check that the base, stand and other fittings of the outdoor unit are not decayed or corroded.
Check that nothing blocks the air inlets and the outlets of the indoor unit and the outdoor unit.
Check that the drain comes smoothly out of the drain hose during COOL or DRY operation. <ul style="list-style-type: none"> • If no drain water is seen, water may be leaking from the indoor unit. Stop operation and consult the service shop if this is the case.

3.4 Before a long idle period

1. Operate the "FAN only" for several hours on a fine day to dry out the inside.
 - Press "MODE" button and select "FAN" operation.
 - Press "ON/OFF" button and start operation.
2. After operation stops, turn off the breaker for the room air conditioner.
3. Clean the air filters and set them again.
4. Take out batteries from the remote controller.

NOTE

- When a multi outdoor unit is connected, make sure the heating operation is not used at the other room before you use the fan operation.

※ Working temperature range		
	Indoor sideDB/WB(°C)	Outdoor sideDB/WB(°C)
Maximum cooling	32/23	43/26
Maximum heating	27/—	24/18

The operating temperature range (outdoor temperature) for cooling unit is -15°C ~ 43°C; for cooling and heating unit is -22°C ~ 43°C.

Working principle and special functions for cooling**Principle:**

Air conditioner absorbs heat in the room and transmit to outdoor and discharged, so that indoor ambient temperature decreased, its cooling capacity will increase or decrease by outdoor ambient temperature.

Anti-freezing function:

If the unit is running in COOL mode and in low temperature, there will be frost formed on the heat exchanger, when indoor heat exchanger temperature decreased below 0°C , the indoor unit microcomputer will stop compressor running and protect the unit.

Working principle and special functions for heating**Principle:**

- * Air conditioner absorbs heat from outdoor and transmits to indoor, in this way to increase room temperature. This is the heat pump heating principle, its heating capacity will be reduced due to outdoor temperature decrease.
- * If outdoor temperature becomes very low, please operate with other heating equipments.

Defrosting:

- * When outdoor temperature is low but high humidity, after a long while running, frost will form on outdoor unit, that will effect the heating effect, at this time, the auto defrosting function will act, the heat running will stop for 8-10mins.
- * During the auto defrosting, the fan motors of indoor unit and outdoor unit will stop.
- * During the defrosting, the indoor indicator flashes, the outdoor unit may emit vapor, This is due to the defrosting, it isn't malfunction.
- * After defrosting finished,the heating will recover automatically.

Anti-cool wind function:

In Heat mode, the following three kinds of status, if indoor heat exchanger hasn't achieve certain temperature that indoor fan motor will not start, in this way to prevent blowing cool wind (within 3mins):

1. Heat operation just startedup.
2. After Auto defrosting operation is finished.
3. Heating under low temperature.

The climate type of this unit is according to the nameplate.

- The temperature should not be set lower than what you need. This would result to increase energy cost.

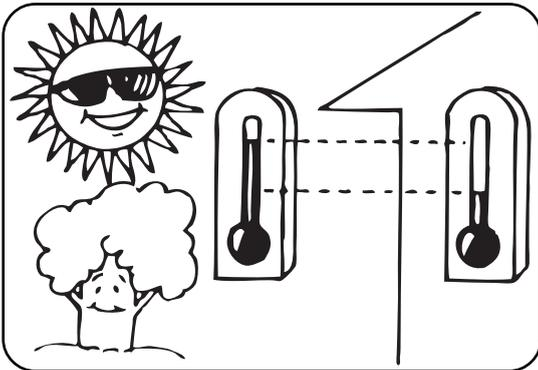

- To distribute cool air through out the room, adjust air flow direction as shown by the arrows (see picture) to diffuse cool air.

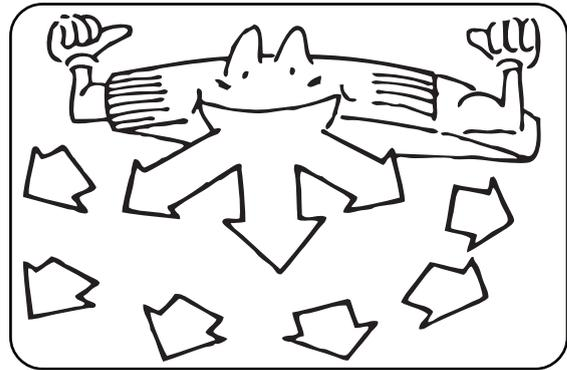

- Clean the air filter every week for higher efficiency.

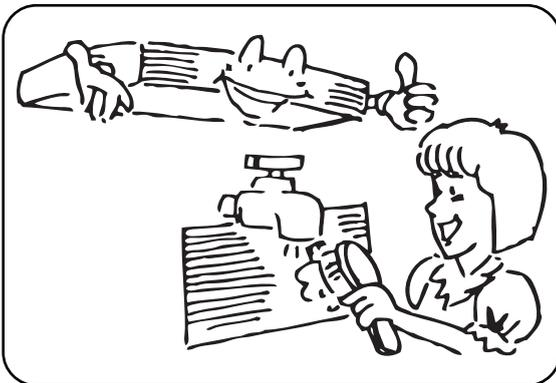

- Close window and door while operating the unit to prevent leakage of cooled air to save energy.

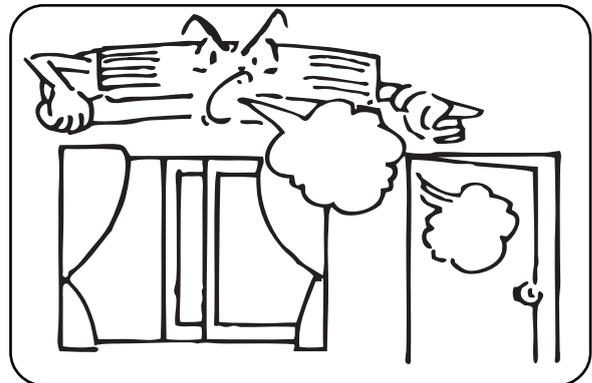

- Draw close curtains or close glass windows when cooling to prevent heat load from sun light which may cause more electricity cost.

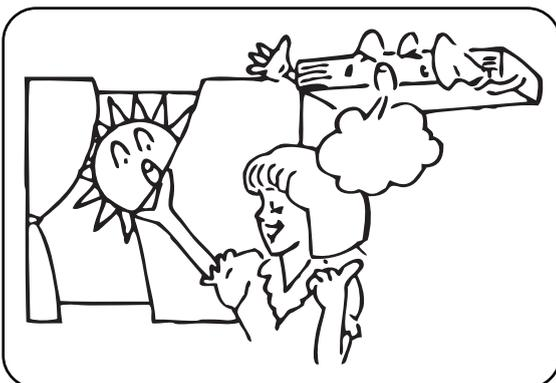

- In case of ineffective ventilation, open the window to ventilate the room air once in a while but not too long since cooled air will be uselessly drained out.

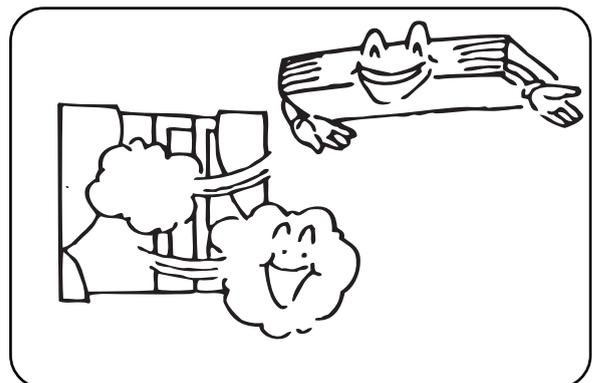

5

Precautions

- Check electrical system(voltage and frequency). Use the proper power supply indicated on the unit to operate the airconditioner and only fuses with specified capacity.Do not use pieces of wire instead of fuse.



- Turn off the airconditioner if ,while running, electricity interference occurs.If the unit is not to be used for a long time,cut off the power supply main switch.

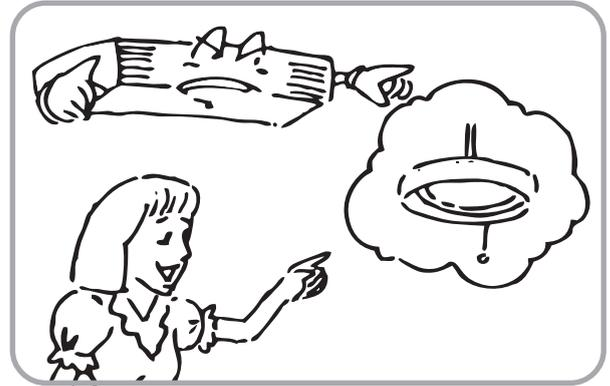

- Do not insert objects into the air inlet or outlet when the airconditioner is running as it may cause damage or personal injury .Also pay special attention when children are around.

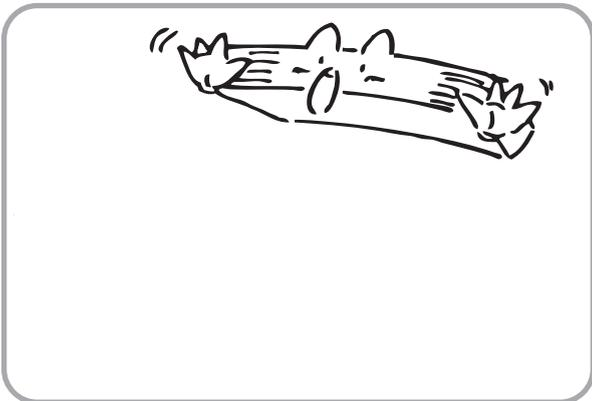

- Do not locate any obstacle against the air flow direction of indoor and outdoor unit. Inefficient performance or malfunction may result.

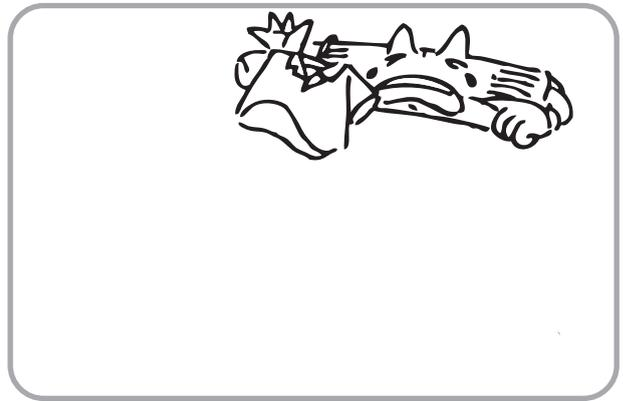

- Do not channel the air flow directly at people, especially infants,aged persons or patients.



- Do not locate a heater or any other heat source close to the unit.The heat may deform plastic parts.



6

Checking before contact the service man

Check the following before contact the service man. You may find the solution to your problems. After checking, if it still does not operate, please contact your local dealer.

PROBLEM	CAUSES
NO operation	<ul style="list-style-type: none"> ● Check if electrical wire is damaged & check if breaker switch is still on. ● Check if the power supply is in order. ● Check if the timer switch is on or not.
The air conditioner runs but does not cool enough.	<ul style="list-style-type: none"> ● Check if the preset temperature is too high. ● Check if the sunlight shines directly into the room. ● Check if the door and window are opened. ● Check if there is anything obstructing the air discharge ● Check if the exhaust fan still operates ● Check if the air filter is dirty or clogged.
Vapor or mist fume coming out of the unit while running.	<ul style="list-style-type: none"> ● Hot air in the room mixes with cool air. This causes smoke fume.
Inoperative remote control.	<ul style="list-style-type: none"> ● Loosened or disconnected wire between the unit and the display. ● Check if the batteries are inserted in correct directions. ● Check if the batteries are exhausted or not.

NOTE CONCERNING PROTECTION OF ENVIRONMENT



This product must not be disposed of via normal household waste after its service life, but must be taken to a collection station for the recycling of electrical and electronic devices. The symbol on the product, the operating instructions or the packaging indicate such disposal procedures. The materials are recyclable in accordance with their respective symbols. By means of re-use, material recycling or any other form of recycling old appliances you are making an important contribution to the protection of our environment. Please ask your local council where your nearest disposal station is located.

INFORMATION CONCERNING USED REFRIGERANT MEDIUM

This unit is containing fluorinated gases included in the Kyoto protocol. The maintenance and the liquidation must be carried out by qualified personnel.

Type of refrigerant: R32

The quantity of the refrigerant: please see the unit label.

The value GWP: 675 (1 kg R32 = 0,675 t CO₂ eq)

GWP = Global Warming Potential



Appliance filled with flammable gas R32.

In case of quality problem or other please contact your local supplier or authorized service center.

Emergency number: 112

PRODUCER

SINCLAIR CORPORATION Ltd.

1-4 Argyll St.

London W1F 7LD

Great Britain

www.sinclair-world.com

This product was manufactured in China (Made in China).

REPRESENTATIVE

SINCLAIR Global Group s.r.o.

Purkynova 45

612 00 Brno

Czech Republic

TECHNICAL SUPPORT

SINCLAIR Global Group s.r.o.

Purkynova 45

612 00 Brno

Czech Republic

Tel.: +420 800 100 285

Fax: +420 541 590 124

www.sinclair-solutions.com

info@sinclair-solutions.com

